

Guida illustrata alla sicurezza nei cantieri



si guardarsi dalla
SICUREZZA SUL LAVORO

A cura di:
U. O. Prevenzione e Sicurezza Ambienti Lavoro
Nucleo impianti e cantieri
Via Gilli, 2 - 38100 Trento
Tel. 0461 364502/00 - fax 0461 364540
E-mail: apss.medlav@tqs.it

I quaderni della collana: Sicurezza sul lavoro
Coordinamento editoriale
Servizio Rapporti con il Pubblico
Azienda Provinciale per i Servizi Sanitari
Via Degasperì, 79 - 38100 Trento
Tel. 0461 364172 - Fax 0461 364170
E-mail: apss.urp@tqs.it • <http://www.apss.tn.it>
Febbraio 2002

PRESENTAZIONE

Dopo la pubblicazione e le riedizioni del Quaderno di cantiere si è pensato di rivolgersi direttamente ai lavoratori del settore edile con una guida costituita da immagini che pur nella loro semplicità e incompletezza contenessero gli elementi più importanti per richiamare l'attenzione sugli aspetti principali della sicurezza e dell'igiene del lavoro nei cantieri edili. Valutata positivamente all'interno della nostra Unità Operativa, l'idea è stata accolta favorevolmente anche al Tavolo Comune sulla sicurezza in edilizia che vede la presenza delle Associazioni di categoria, dei Sindacati, del Centrofor e degli Ordini e Collegi professionali.

Questa guida per immagini già stampata dal Dipartimento di Sanità Pubblica della Città di Bologna, non era tuttavia disponibile per la diffusione tra i lavoratori edili in provincia di Trento, per cui era necessaria una ristampa, gentilmente concessa senza vincoli di copyright.

Pertanto si è apportata qualche modifica al testo e sono state aggiunte alcune tavole, relative agli aspetti più rilevanti di igiene del lavoro, cercando tuttavia di conservare l'impostazione originaria: contenuti di intuitiva ed immediata acquisizione.

La comprensione del messaggio è comunque facilitata dalla didascalia nelle lingue più diffuse tra la manodopera extracomunitaria che in questi ultimi anni è sensibilmente aumentata nella cantieristica.

Si ritiene auspicabile che anche questa iniziativa, rivolta ai lavoratori del settore edile, possa inserirsi in quel contesto di programmazione della prevenzione che, predisposta dal datore di lavoro deve vedere il coinvolgimento sia nell'ideazione nell'attuazione di tutte le parti interessate, ovvero dirigenti, preposti e lavoratori.

L'informazione e la formazione dei lavoratori, come delle altre figure che cooperano al processo produttivo, hanno una decisa rilevanza ai fini della prevenzione negli ambienti di lavoro.

Per avere consentito questa opportunità a carattere informativo si esprime quindi un sincero ringraziamento al Dipartimento di Sanità Pubblica della Città di Bologna, al nucleo Medicina del Lavoro di Trento e al Centrofor per la collaborazione nella stesura.

IL RESPONSABILE
DEL NUCLEO IMPIANTI E CANTIERI
dott. ing. Carlo Felice Suppa

No!!
Jo!!
Non!!
No!!
لا !!

TAV. 1

Proteggi mani, occhi e viso
Mbëroj duart sytë dhe fytyren
Se protéger les mains, les yeux et le visage
Protect hands, eyes and face.

احم اليدين والعينين والوجه

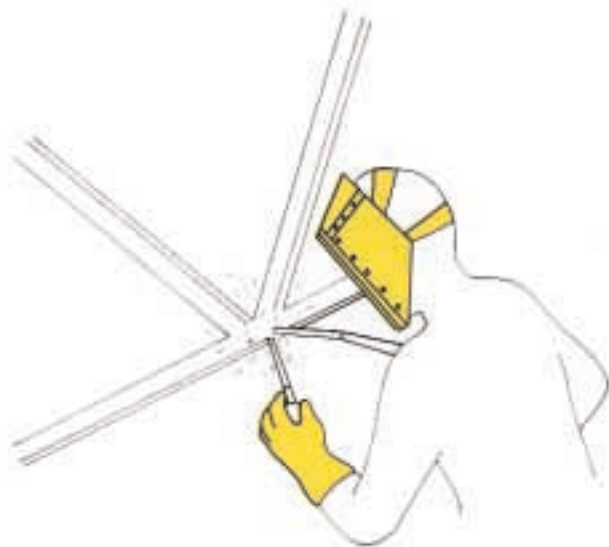
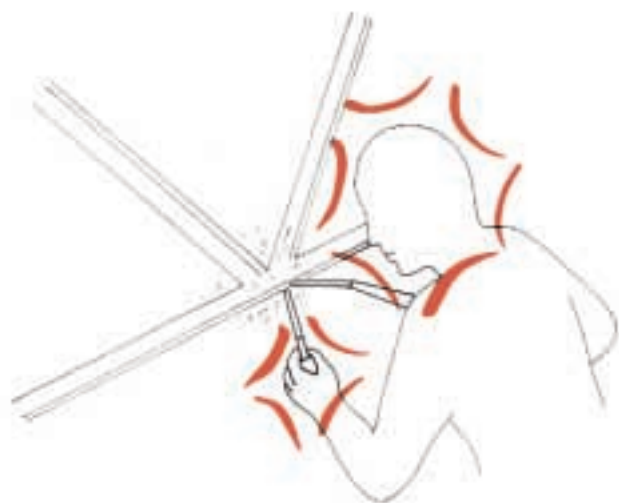

No!
Jo!
Non!
No!
لا !!

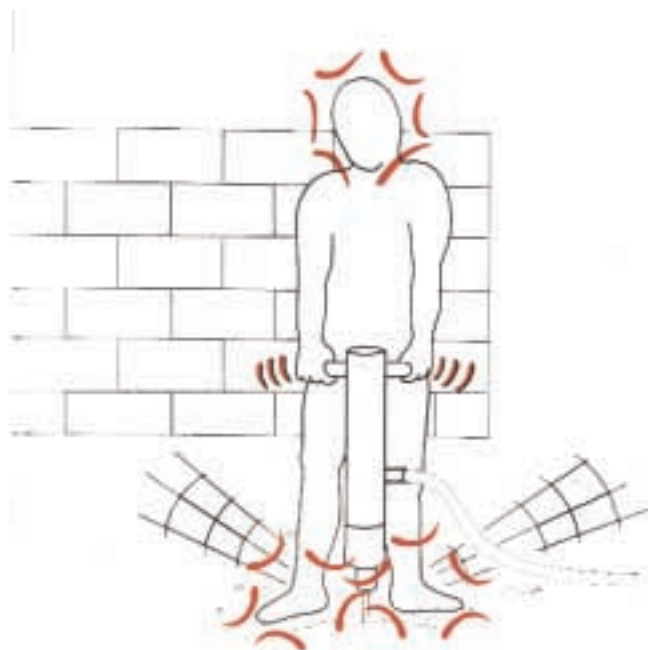

TAV. 2

Proteggi occhi, orecchie, mani e piedi
Mbëroj sytë, veshët, duart dhe këmbët
Se protéger les yeux, les oreilles, les mains et les pieds
Protect eyes, ears, hands and feet.

احم العينين والأذنين واليدين والقدمين



No!!
Jof!
Non!!
No!!
!! لا

TAV. 3

Proteggi occhi, orecchie, mani e piedi
Mbëroj sytë, veshët, duart dhe këmbët
Se protéger les yeux, les oreilles, les mains et les pieds
Protect eyes, ears, hands and feet.

احم العينين والأذنين واليدين والقدمين



No!!
 Jo!!
 Non!!
 No!!
 !! لا



Proteggi occhi, orecchie, mani naso e bocca
 Mbëroj sytë, veshët, hunden, dhe duart
 Se protéger les yeux, les oreilles, le nez, la bouche et les mains
 Protect eyes, ears, nose, mouth and hands.

احم العينين والاذنين والانف والفم واليدين



TAV. 5

No!/
Jo!/
Non!/
No!/
!! لا

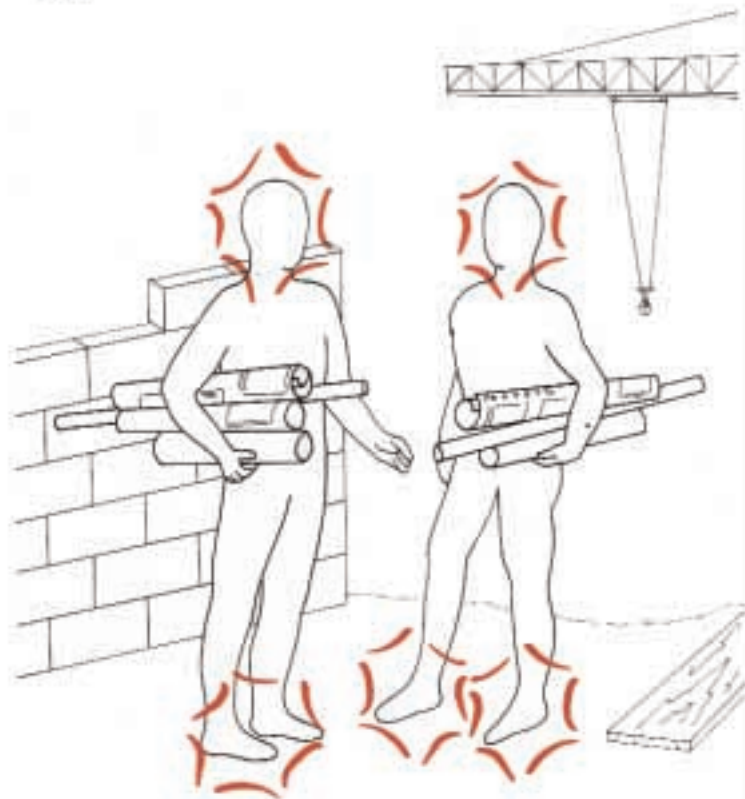

Proteggi la testa e i piedi
Mbëroj kokën dhe këmbët
Se protéger la tête et les pieds
Protect head and feet.

احم الرأس والقدمين

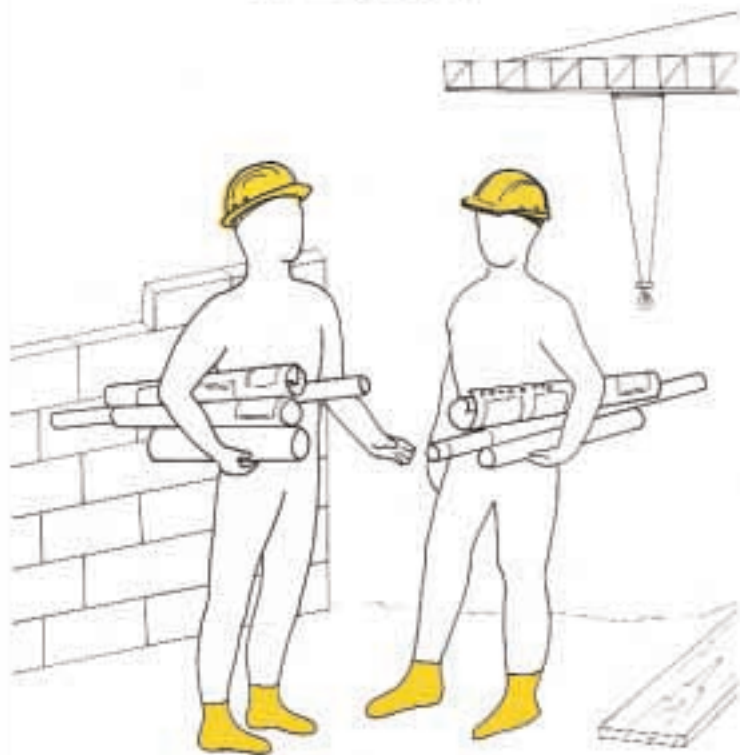

No!!
Joff
Non!!
No!!
!! Y

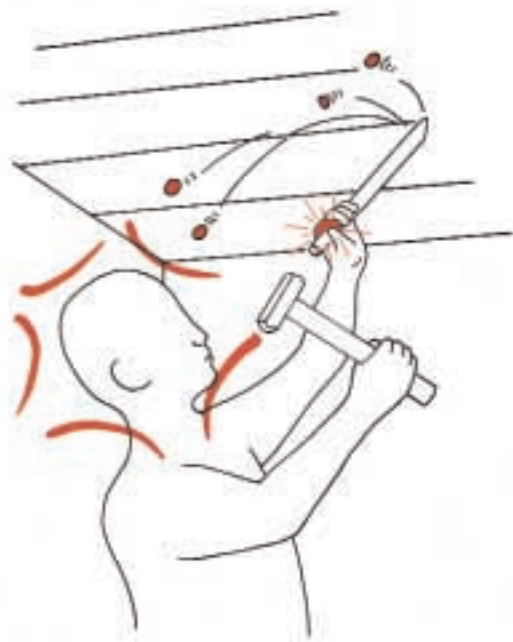

TAV. 6

Proteggi testa, occhi e mani
Mbëroj kokën sytë dhe duart
Se protéger la tête, les yeux et les mains
Protect head, eyes and hands.

احم الرأس والعينين واليدين



No!!
Joff
Non!!
No!!
!! لا

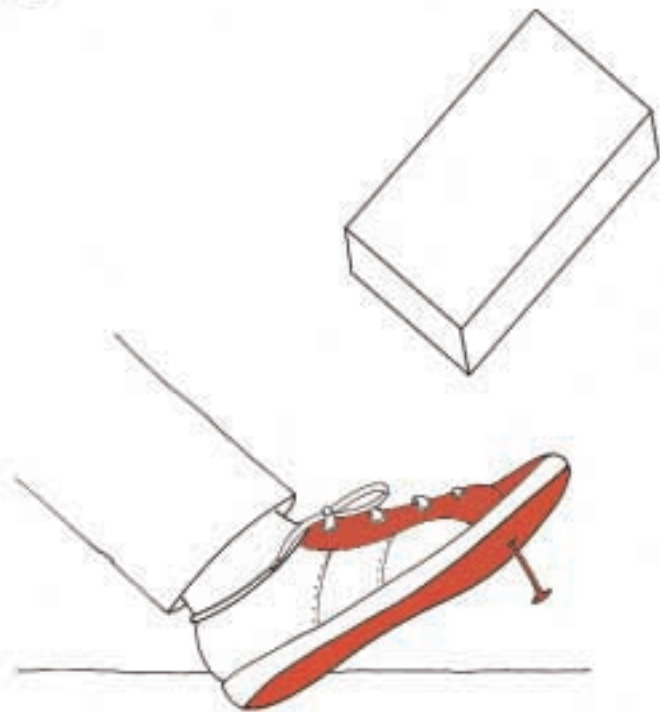

Proteggi i piedi
Mbëroj këmbët
Protèger les pieds
Protect feet

إحم الرجلين

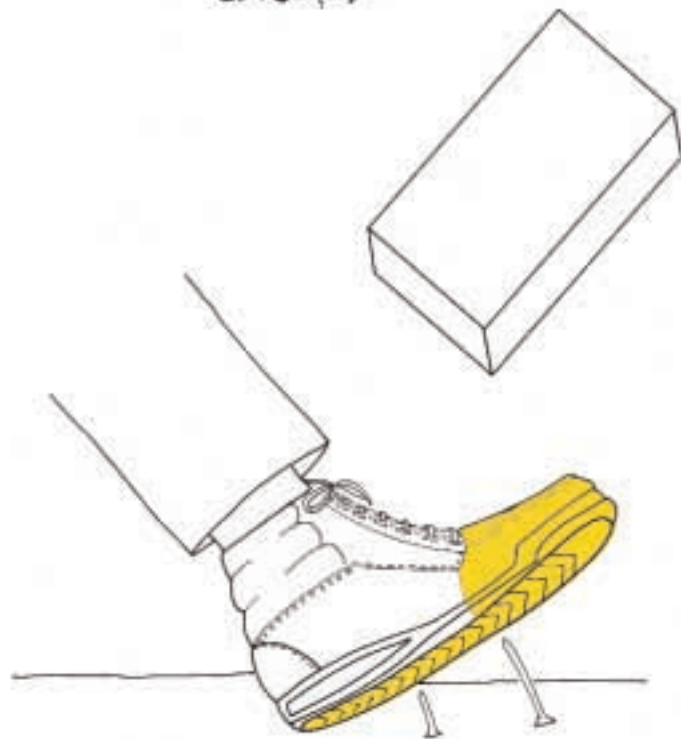

Noll
 Jo!
 Non!
 Noll
 !! لا

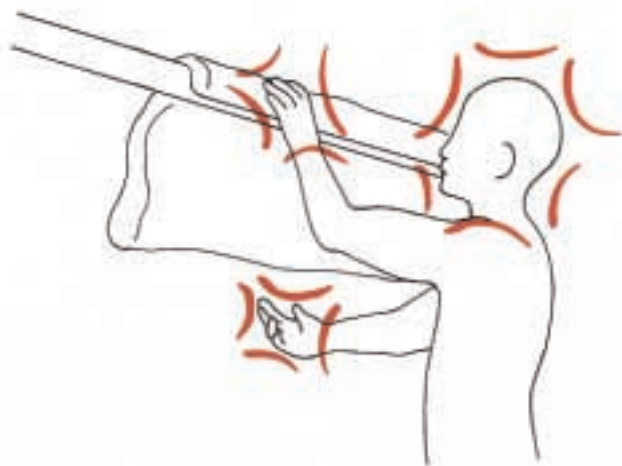

Fibre di lana minerale: usa guanti e maschera
 Fije leshi mineral: përdor doreza dhe maskë
 Fibres de laine minerale: utiliser des gants et un masque
 Mineral wool fibers: use gloves and mask

ألياف صوفية ومعديّة: إستعمل قفازات وكمّامة

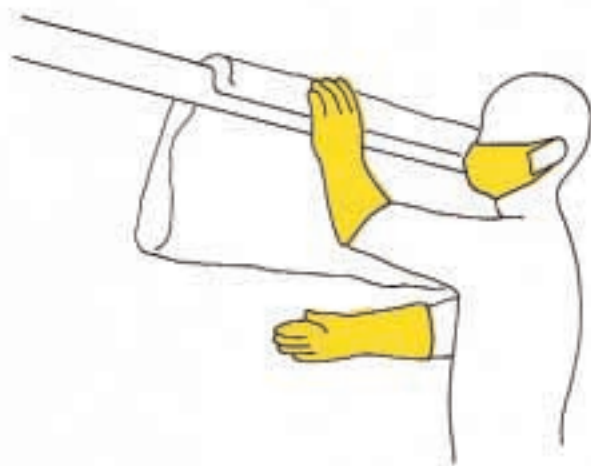

No!!
Jo!!
Non!!
No!!
!! لا

TAV. 9

Proteggi le mani
Mbëro duart
Protèger les mains
Protect hands

إحم اليدين

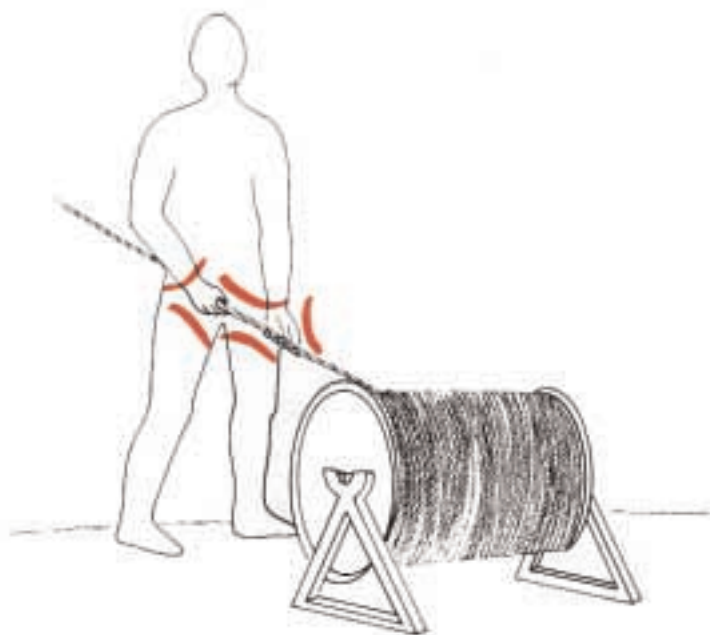

Pericolo: caduta dalla scala
Rrezik: Rënie nga shkalla
Risque: chute de l'échelle
Danger: falling from ladder

خطر سقوط عن السلم



TAV. 10

Usa la cintura di sicurezza
Përdor brezin e sigurimit
Utiliser la ceinture de securite
Use safety belt

إستعمل زئار الأمان

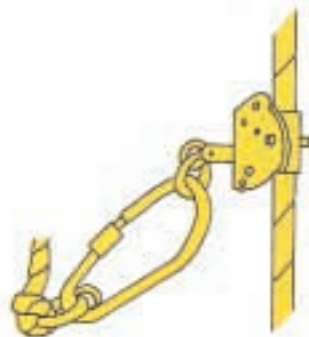

TAV. 11

Pericolo: caduta nel vuoto
Rrezik: Rënie në boshllëk
Risque: chute dans le vide
Danger: falling

خطر سقوط في الفراغ

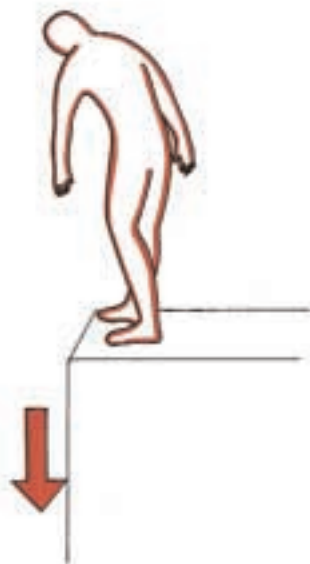

Usa la cintura di sicurezza con freno di emergenza
Përdor brezën e sigurimit me fren emergjence
Utiliser la ceinture de securite avec le frein de secur
Use safety belt with emergency brake

إستعمل زئار الأمان مع مكبح الطوارئ

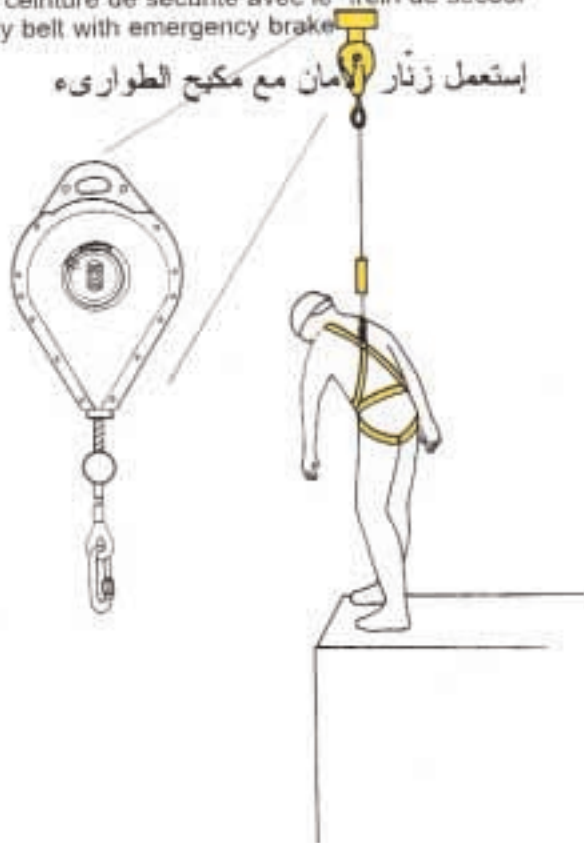

Pericolo: caduta dal tetto
Rrezik: Rënie nga çatia
Risque: chute du toit
Danger: falling from roof
خطر سقوط عن السطح

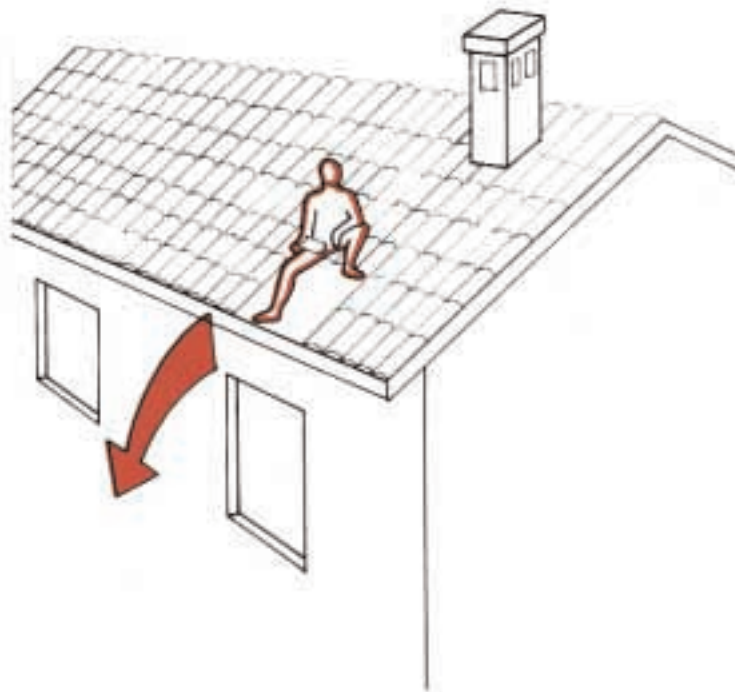

Usa la cintura e proteggi la testa
Përdor brezën dhe mbro koken
Utiliser la ceinture et protéger la tête
Use belt and protect head

إستعمل الزنار واحم الرأس

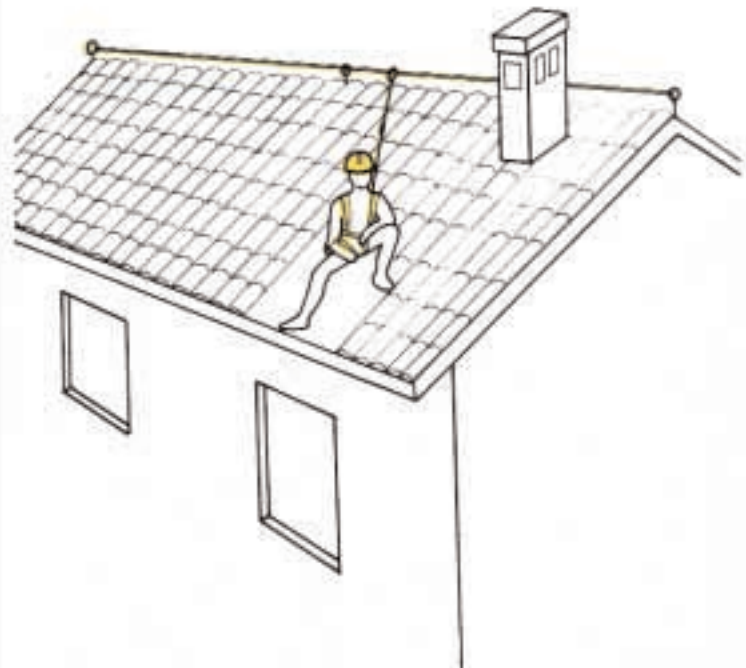

TAV. 13

Pericolo: caduta dal tetto
Rrezik: Rënie nga çatia
Risque: chute du toit
Danger: falling from roof

خطر سقوط عن السطح

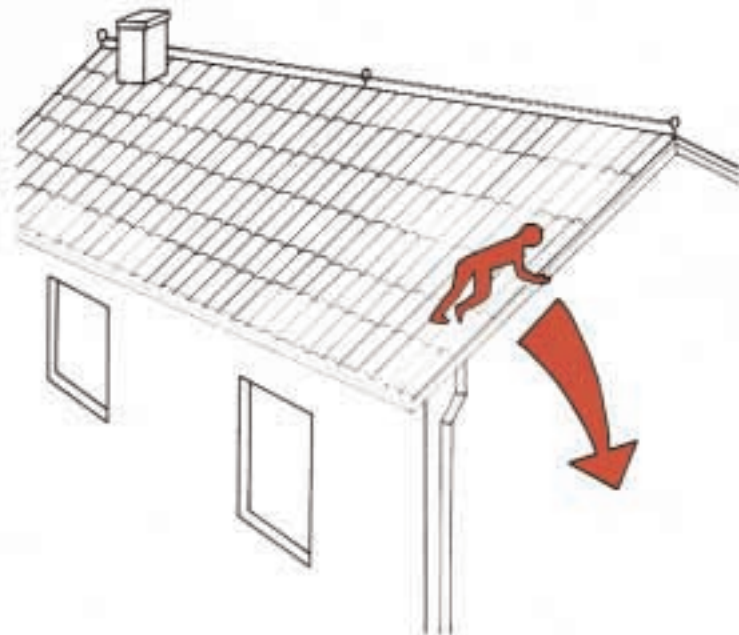

Usa la cintura di sicurezza collegata alla fune
Përdor brezën e sigurimit të lidhur në kavo
Utiliser la ceinture de securite reliee au cable
Use safety belt hooked to cable

إستعمل زئار الأمان موصولاً بالقضيب الفولاذي

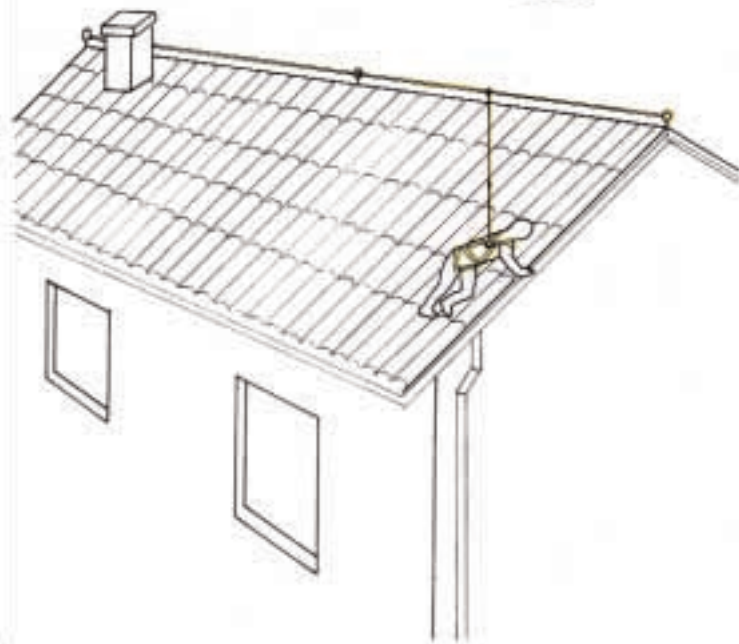

Ancoraggio pericoloso
Fiksīm i rrezikshēm
Ancrage dangereux
Hazardous anchoring

ربطاً خطر

TAV. 14

Usa ancoraggi sicuri
Përdor fiksime të sigurta
Utiliser des ancrages surs
Use safe anchors

إستعمل مرابطاً آمنة

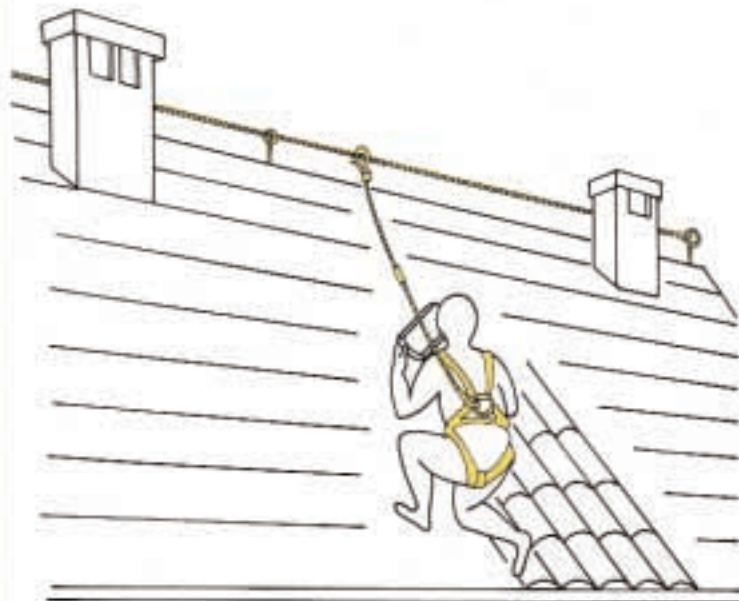
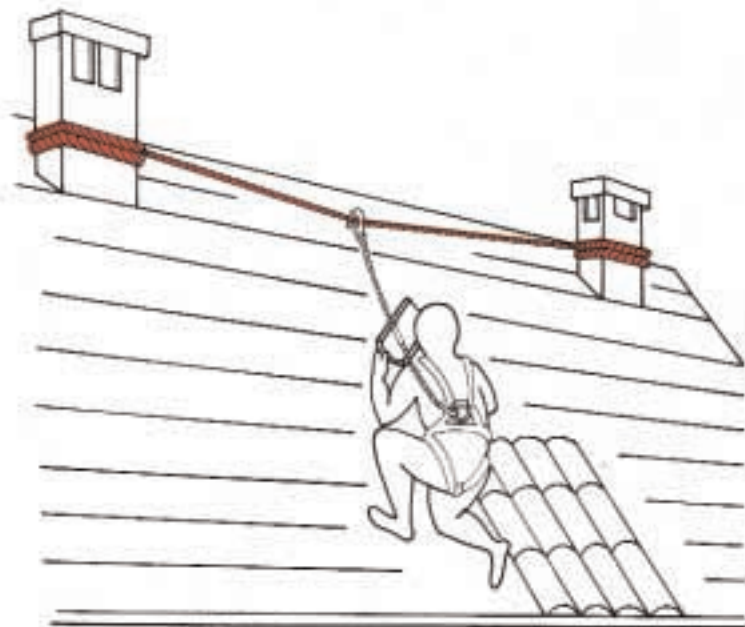

TAV. 15

Pericolo: caduta dal tetto
Rrezik: Rënie nga çatia
Risque: chute du toit
Danger: falling from roof
خطر سقوط عن السطح



Usa la cintura di sicurezza collegata alla fune
Përdor brezën e sigurimit të lidhur në kavo
Utiliser la ceinture de securite reliee au cable
Use safety belt hooked to cable

إستعمل زئجار الأمان موصولاً بالقضيب الفولاذي

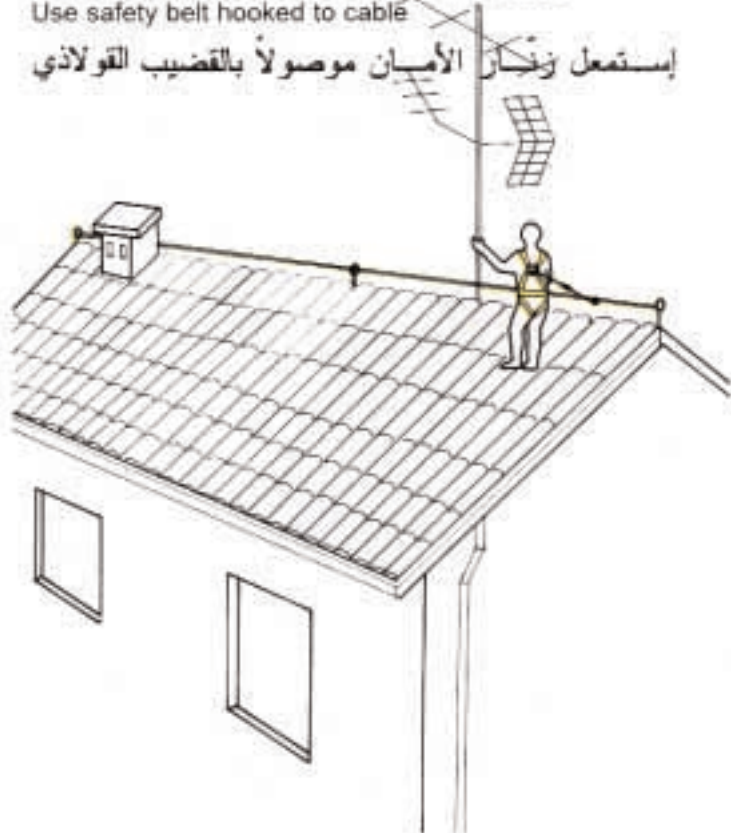

Pericolo: base di appoggio improvvisata
Rrezik: Bazë mbështetjeje e improvizuar
Risque de: chute dans le vide
Danger: improvised support

خطر قاعدة ربط مرتجلة

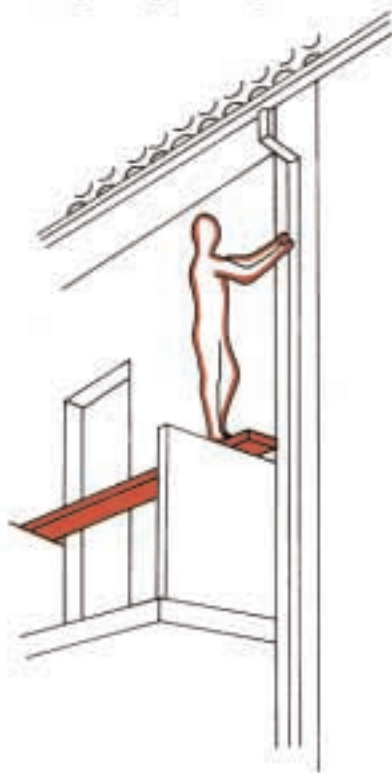

TAV. 16

Usa ponti adeguati
Përdor skelë të përshtatshme
Preparer un echafaudage de travail sur
Use adequate scaffolding

استعمل جسوراً ملائمة



Pericolo di caduta nel vuoto
Rezik rënie në boshllëk
Risque de chute dans le vid
Danger of falling

خطر سقوط في الفراغ

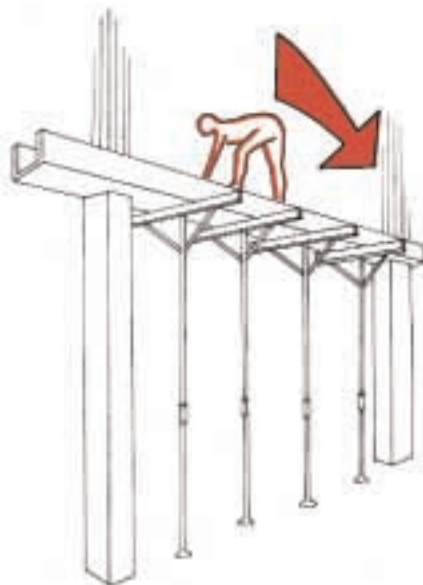

TAV. 17

Predisponi un ponte di lavoro sicuro
Parapërgatit një skelë të sigurt për punë
Utiliser la ceinture de securite
Prepare safe scaffolding

أعد جسراً آمناً للعمل



Pericolo di caduta nel vuoto
Rrezik rënie në boshllëk
23. Risque de chute dans le vide
Danger of falling

خطر سقوط في الفراغ

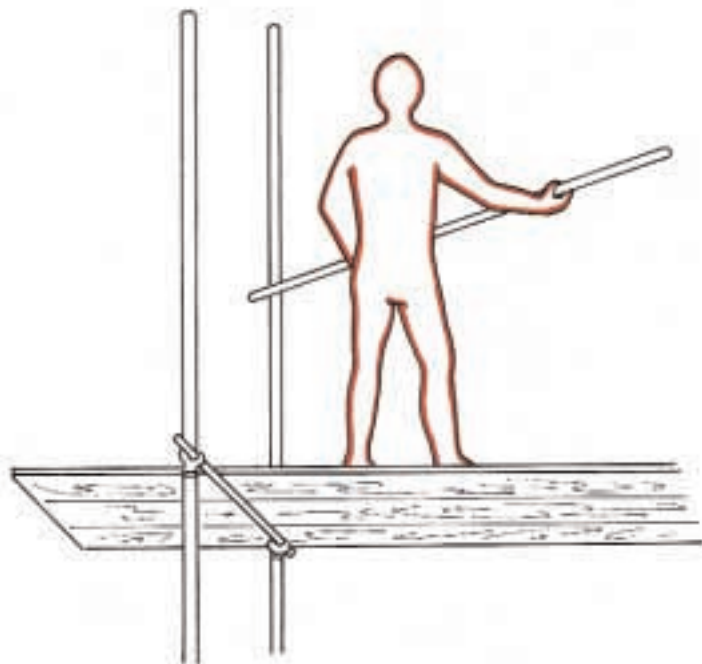

TAV. 18

Usa la cintura di sicurezza
Përdor brezën e sigurimit
Utiliser la ceinture de securite
Use safety belt

إستعمل زئار الأمان

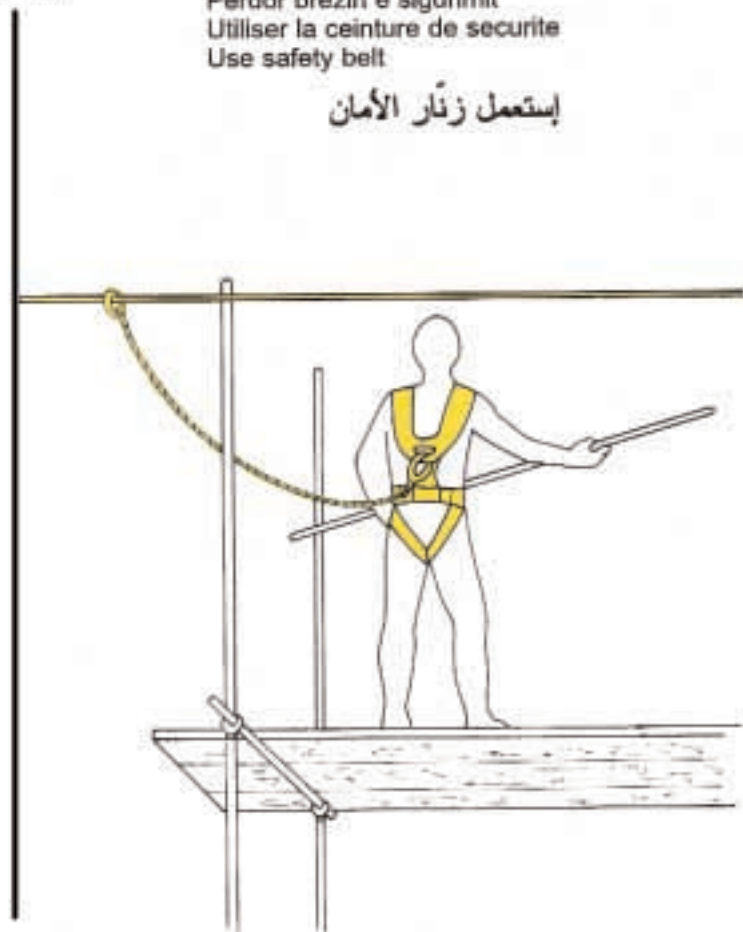

Pericolo di instabilità
 Rrezik paqëndrueshmërie
 Risque d'instabilité
 Danger of instability

خطر عدم استقرار

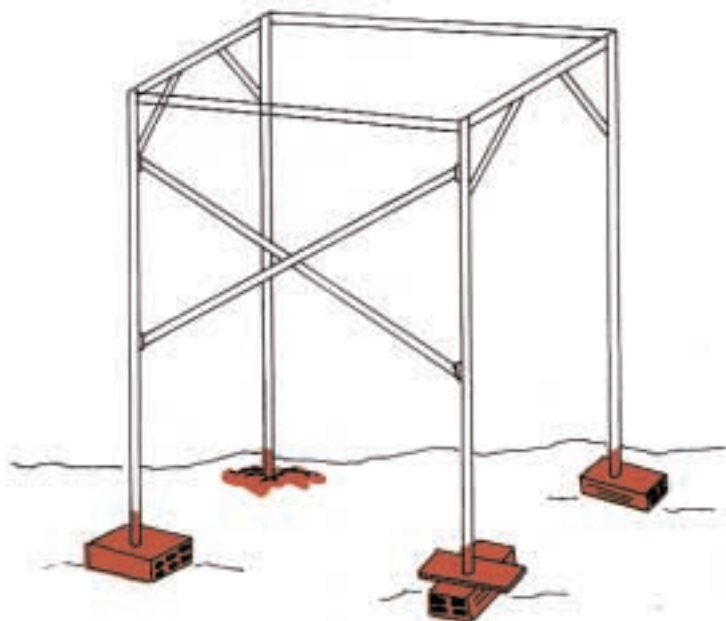

Distribuisci bene il carico
 Shpërnda mirë ngarkesën
 Bien distribuer la charge
 Distribute loads properly

وزع الحمل توزيعًا جيدًا

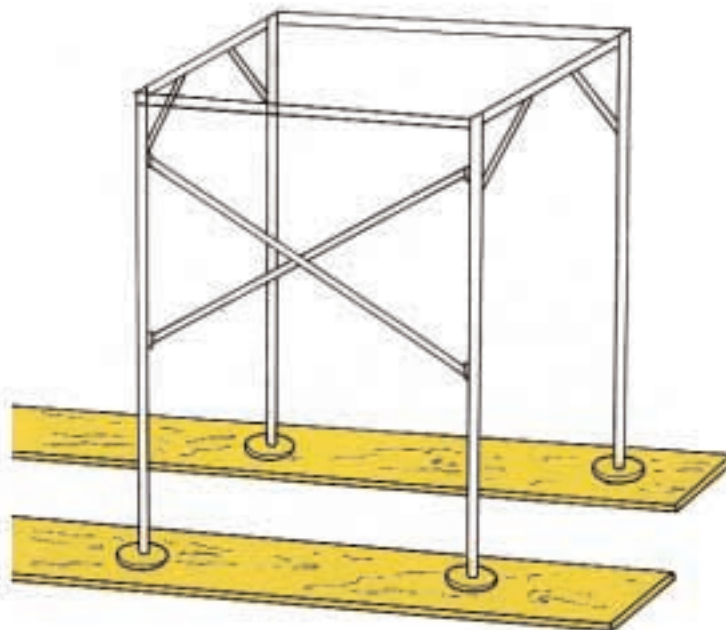

Non improvvisare gli ancoraggi
Mos improvizo mënyrat e fiksimit
Ne pas improviser les ancrages
Do not improvise anchors

لا ترتجل طرق الربط

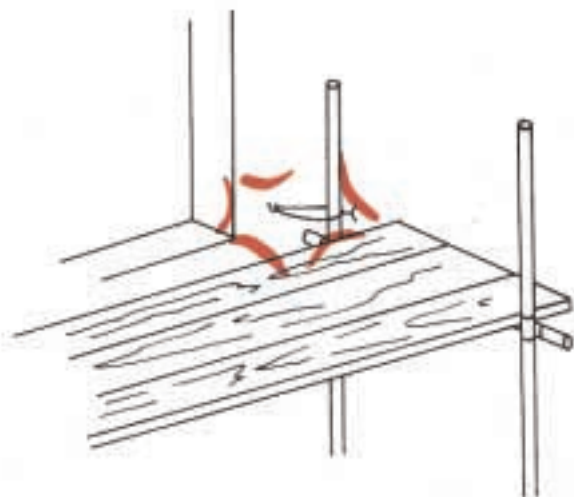

Utilizza sistemi autorizzati
Fiksohu me mjete të autorizuara
Attacher l'échafaudage avec des systèmes autorisés
Fasten with authorized means

تثبيت نفسك بواسطة نُظْم مسموح بها

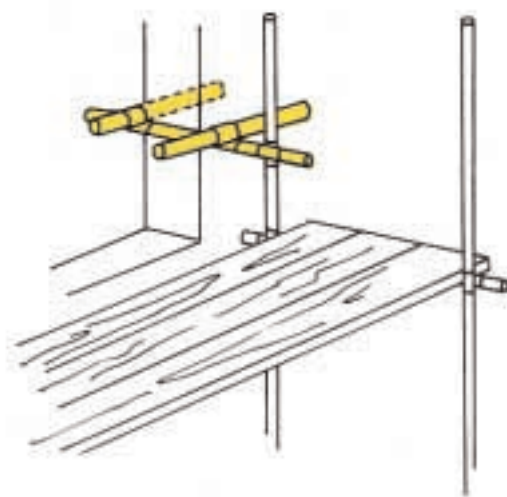

Pericolo di caduta nel vuoto
 Rrezik rënie në boshllëk
 Risque de chute dans le vide
 Danger of falling

خطر سقوط في الفراغ



Tieni l'impalcato aderente alla costruzione
 Mbahe skelën të përputhur me ndërtesën
 Maintenir l'échafaudage contre la construction
 Keep scaffolding close to building

اجعل السقالة ملاصقة للبناء

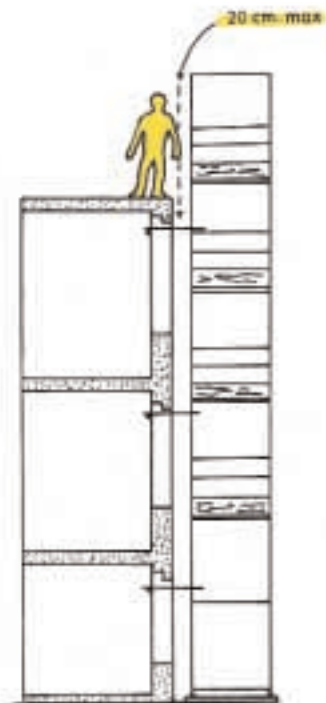

TAV. 22

Pericolo di caduta nel vuoto
Rrezik rënje në boshllëk
Risque de chute dans le vide
Danger of falling

خطر سقوط في الفراغ

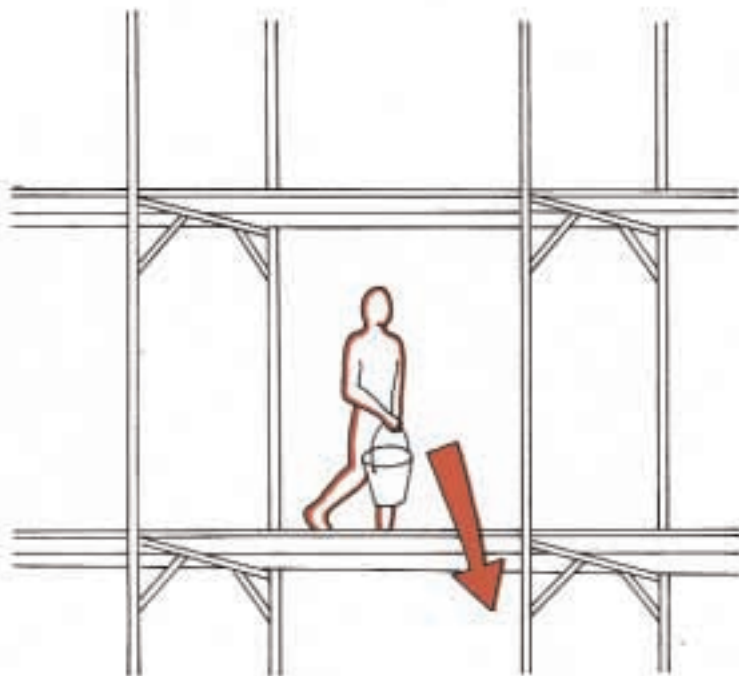

Monta il parapetto, la diagonale di facciata e di pianta
Monto parapetin, diagonalen ballore dhe të bazës mbështetëse
Monter le parapet, la diagonale de facade et de plan
Mount railing, side and top traverse beams

رَكِب الحاجز والقضيب المنحرف للبنية في الواجهة والمسطح

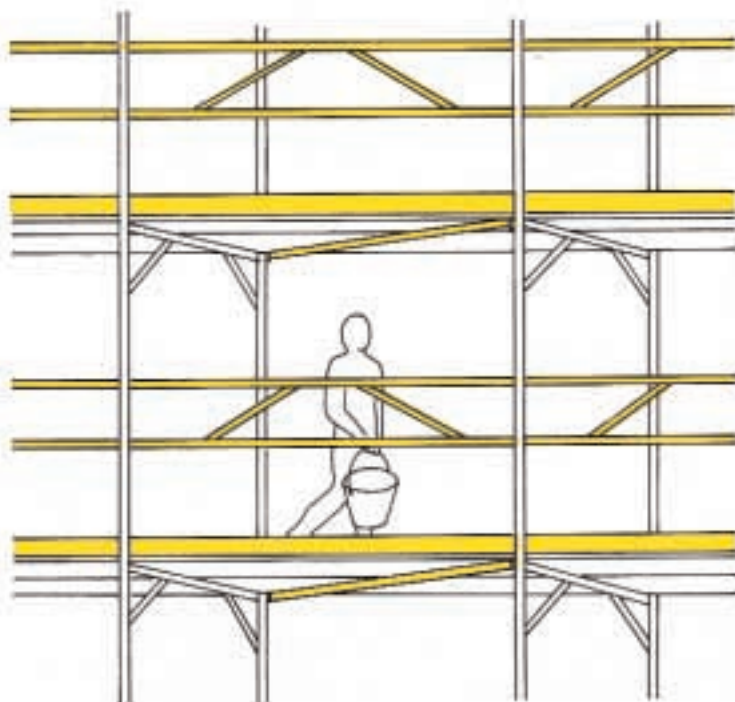

Non arrampicarti sul ponteggio
Mos u ngjit mbi skelë
Ne pas grimper sur l'échafaudage
Do not climb on scaffold

لا تتعمشق بالسقالة

TAV. 23

Usa la scala
Përdor shkallën
Utiliser l'échelle
Use stairs

استعمل السلم

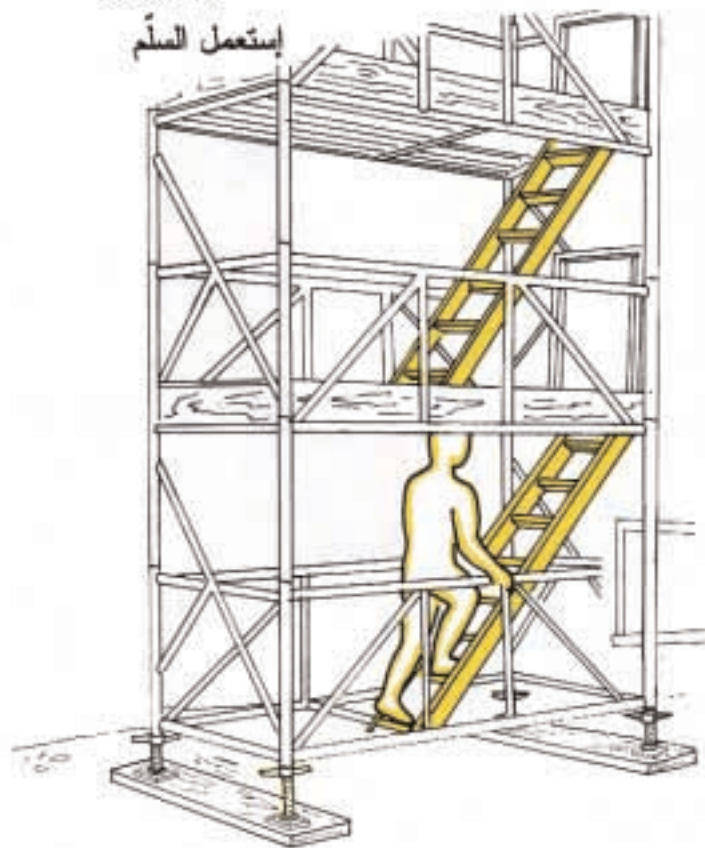
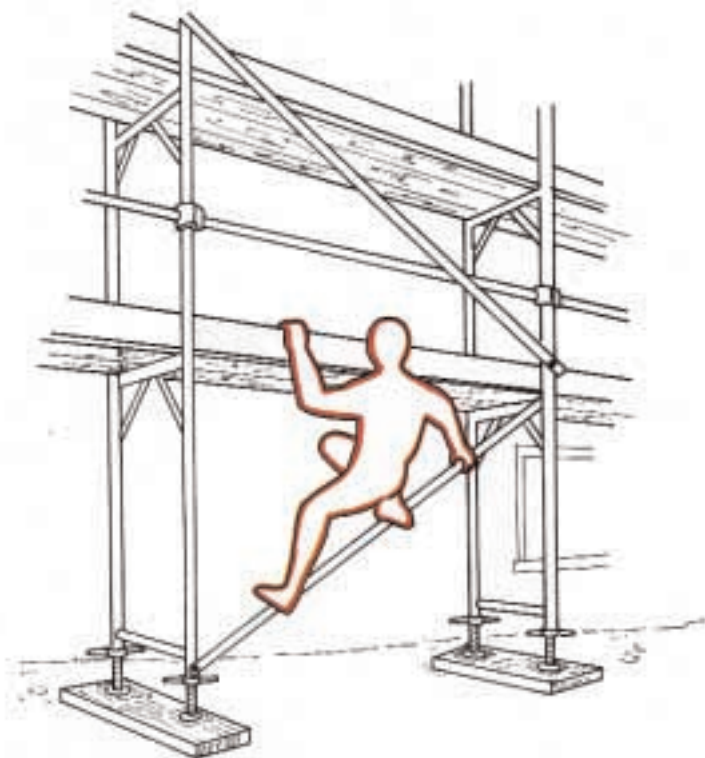

Pericolo di caduta nel vuoto
Rrezik rënie në boshllëk
Risque de chute dans le vide
Danger of falling

خطر سقوط في الفراغ

TAV. 24

Usa un ponte sicuro
Përdor skelë të sigurt
Utiliser un pont sur
Use safe scaffolding

إستعمل جسراً آمناً

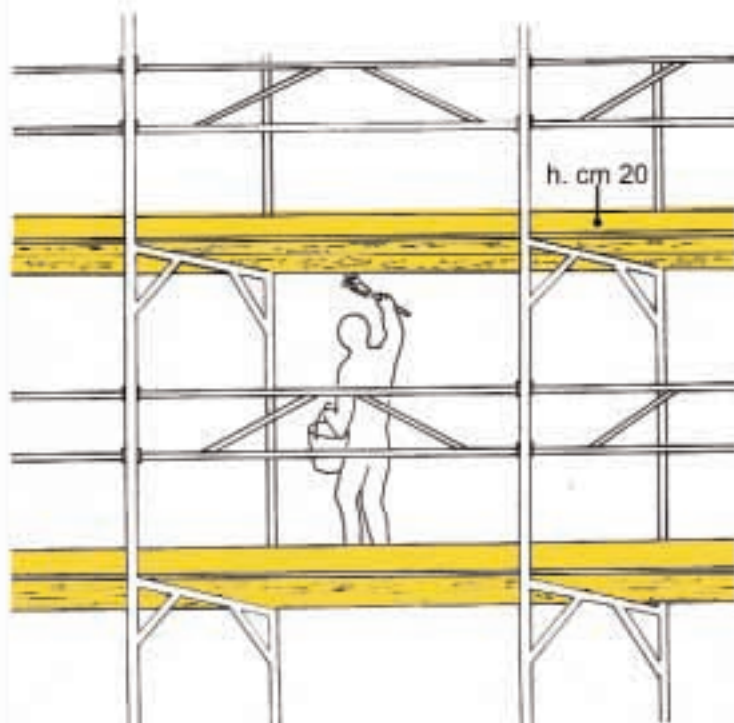
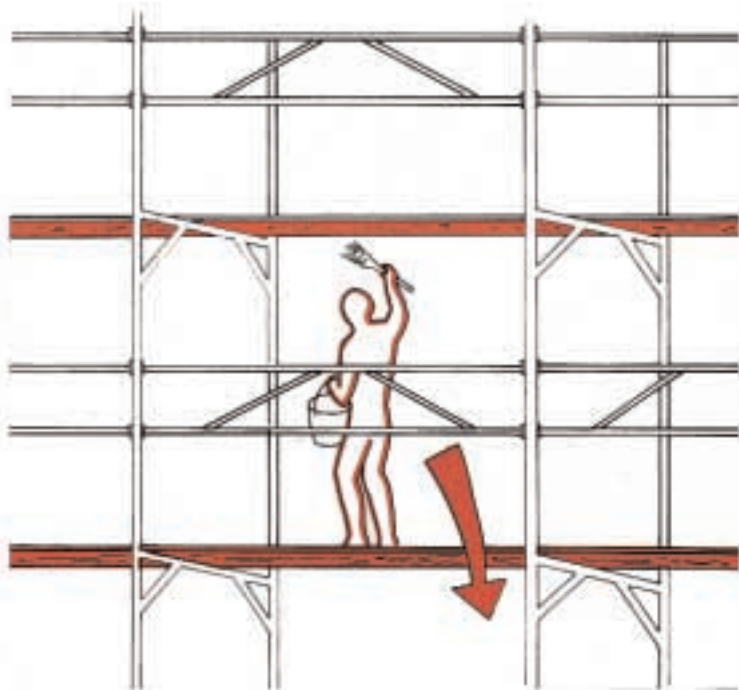

Pericolo di caduta nel vuoto
Rrezik rënie në boshllëk
Risque de chute dans le vide
Danger of falling

خطر سقوط في الفراغ

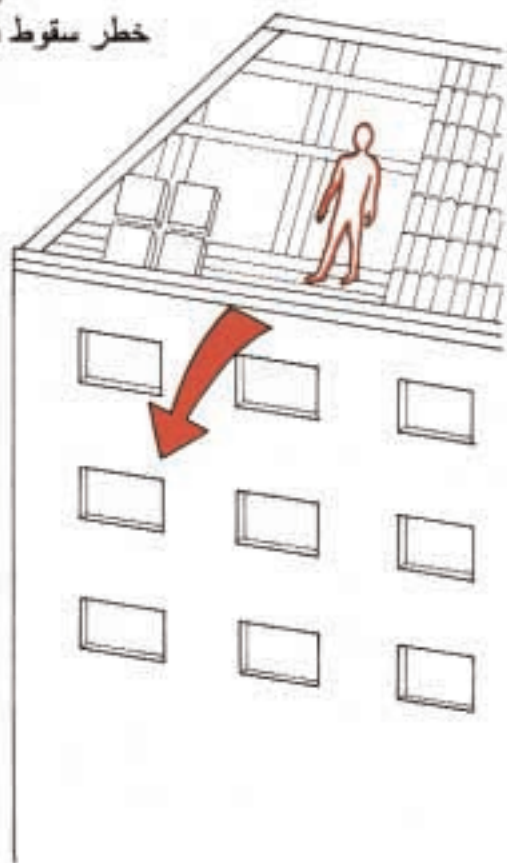

TAV. 25

Monta il ponteggio
Monto skelën
Monter l'échafaudage
Build scaffolding

رَكِب السقالة

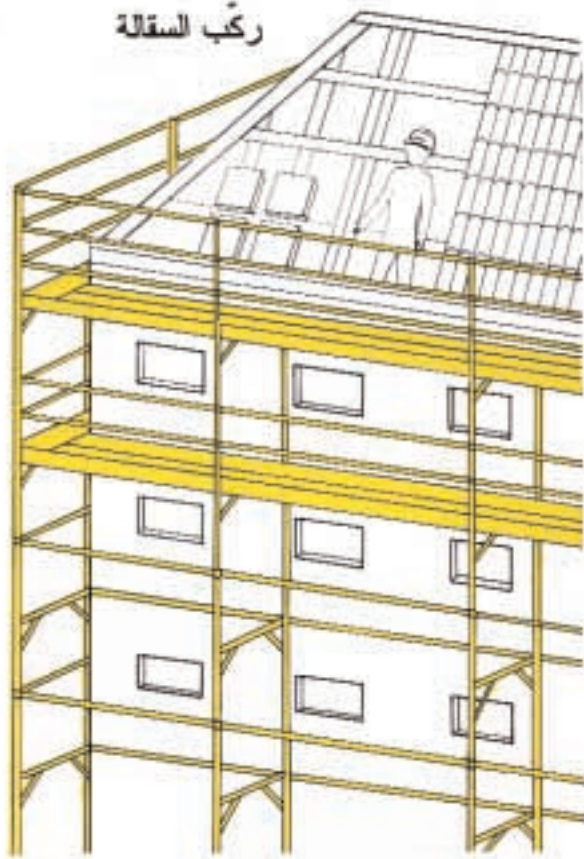

Pericolo di caduta
Rrezik rënie
Risque de chute
Danger of falling

خطر سقوط

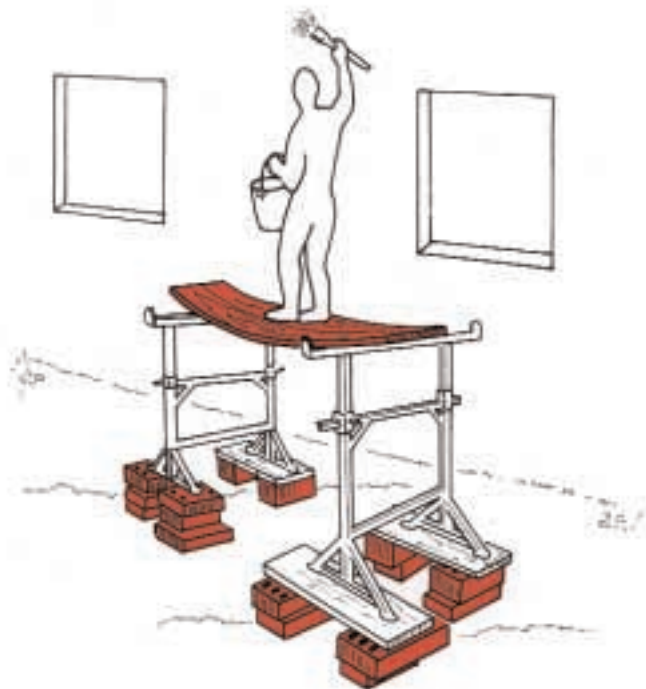

TAV. 26

Usa un appoggio stabile
Përdor një mbështetje të qëndrueshme
Utiliser un appui stable
Use stable supports

إستعمل مرتكزاً ثابتاً

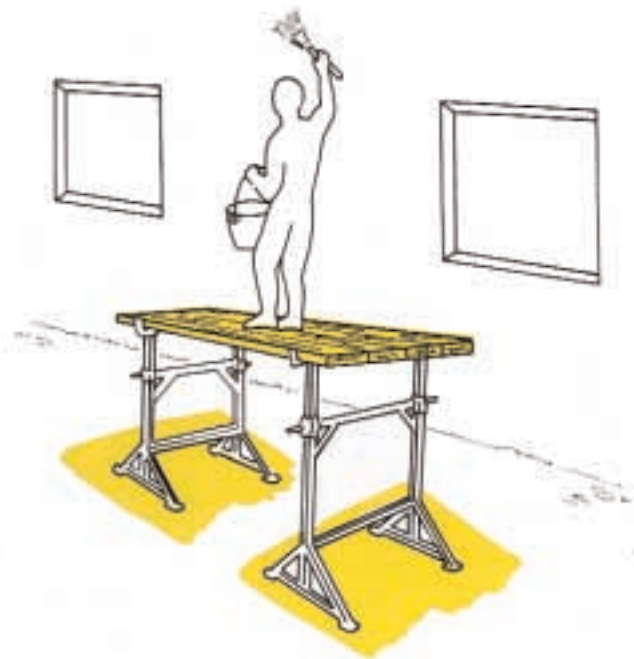

Non arrampicarti sul ponteggio
Mos u ngjit mbi skele
Ne pas grimper sur l'échafaudage
Do not climb on scaffold

لا تتعمشق بالسقالة

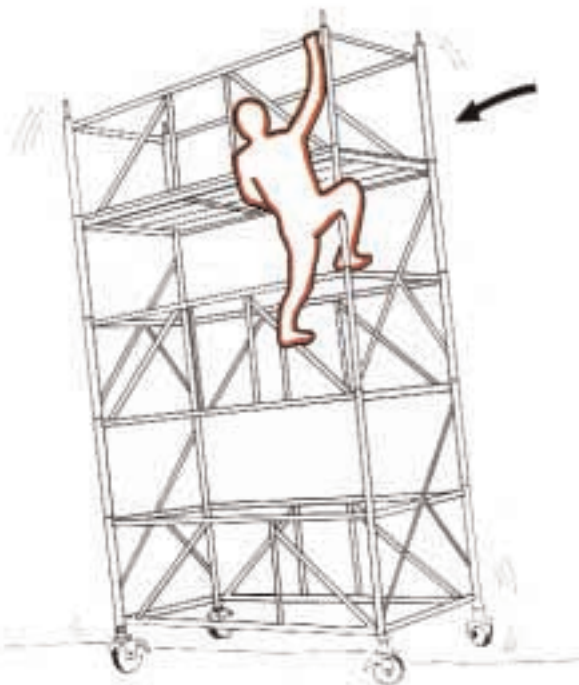

TAV. 27

Usa la scala
Përdor shkallën
Utiliser l'échelle
Use stairs

إستعمل السلم

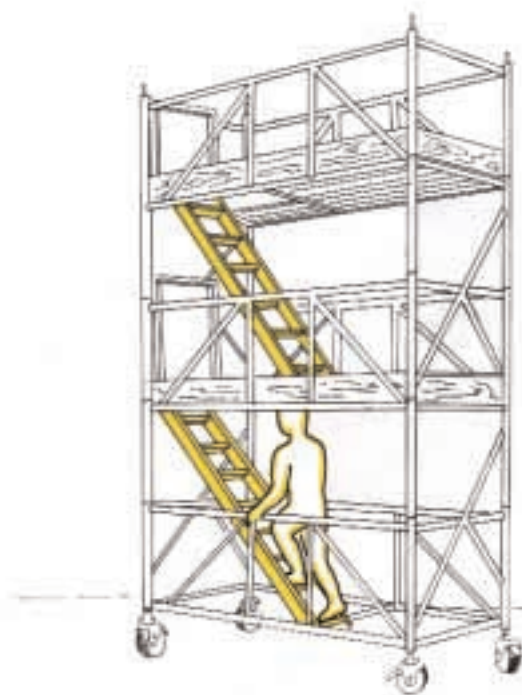

Pericolo di caduta
 Rrezik rënie
 Risque de chute
 Danger of falling

خطر سقوط



Usa un ponte sicuro e scendi prima di spostarlo
 Përdor skelë të sigurt dhe zbrit para se t'ja spostosh
 Utiliser un échafaudage sûr et descendre avant de le déplacer
 Use safe scaffolding and descend before moving.

پستعمل جسرا آمنا وانزل قبل أن تنقله



Pericolo di caduta
 Rrezik rënie
 Risque de chute
 Danger of tipping

خطر سقوط



Rispetta le indicazioni del costruttore
 Respekto udhëzimet e ndërtuesit
 Respecter les indications du constructeur
 Follow manufacturer instructions

تقيد بتعليمات البناء

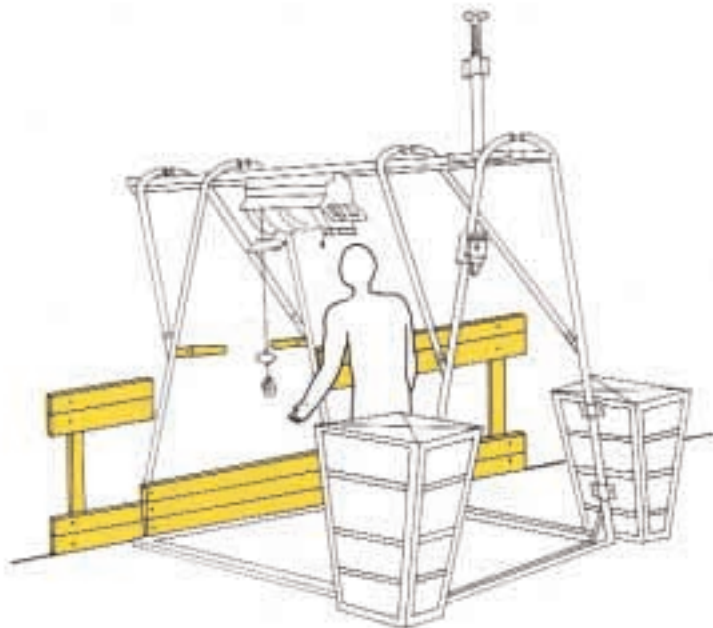

Pericolo di schiacciamento
Rezik shtypje
Risque d'écrasement
Danger of crushing

خطر سحق

TAV. 30

Garantire la distanza di sicurezza da ostacoli
Garanto largesin sigurimit nga pengesat
Garantir une distance de sécurité par rapport aux obstacles
Keep safety distance from obstacles.

أضمن مسافة الأمان من العوائق

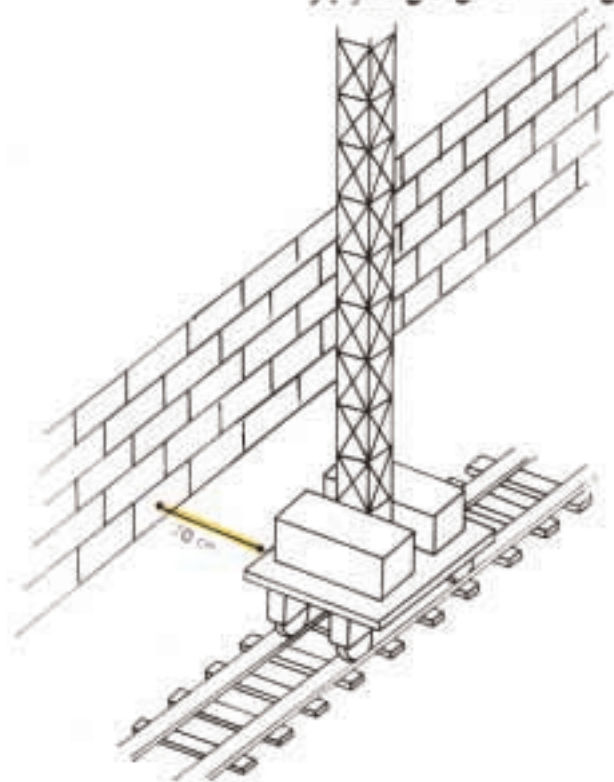
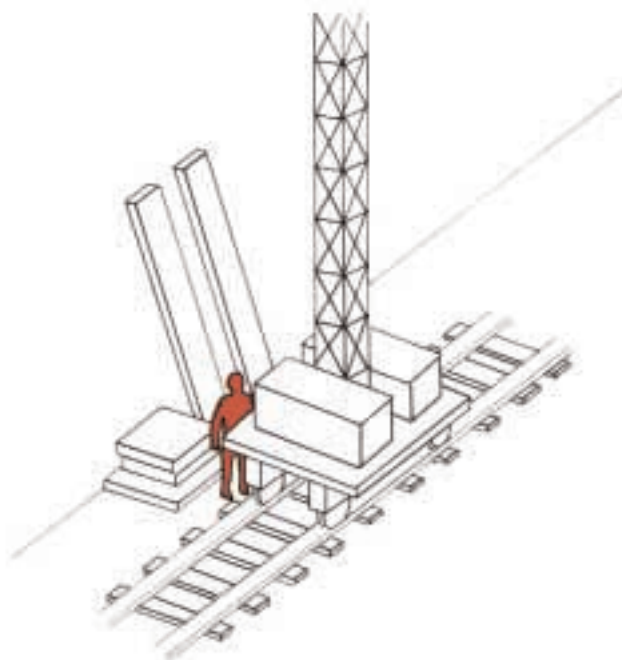

Pericolo di schiacciamento
Rrezik shtypje
Risque d'écrasement
Danger of crushing

خطر سحق

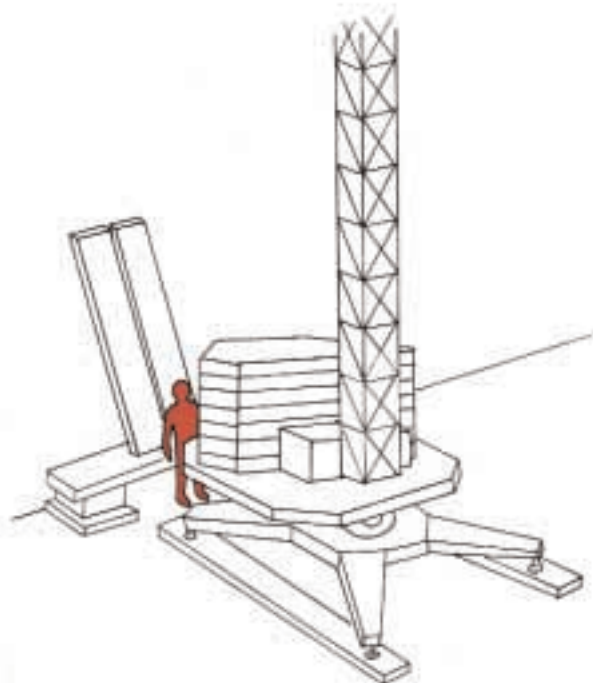

TAV. 31

Delimita la zona di movimento del mezzo
Kufizo zonën e lëvizjes së mjetit
Delimiter la zone de mouvement de l'engin
Designate safety transport areas

حدّد منطقة تحرك الوسيلة

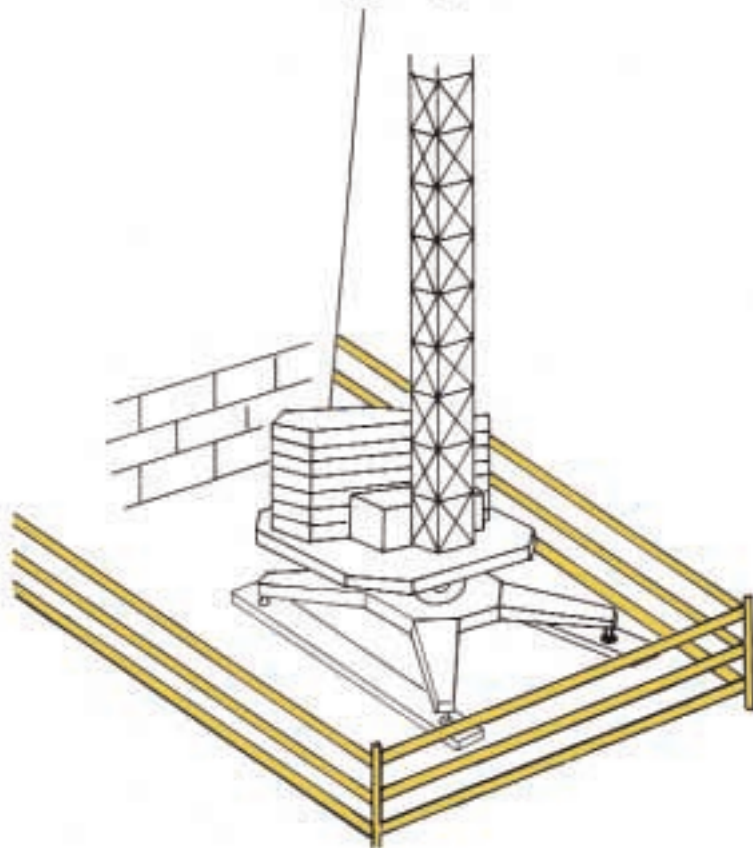

Pericolo di caduta materiale
Rrezik rënie materialesh
Risque de chute de matériaux
Danger of falling material

خطر سقوط موادّ



TAV. 32

Non sostare sotto i carichi
Mos u ndal poshtë peshave
Ne pas rester sous les charges
Do not stand under loads

لا تقف تحت الحمل

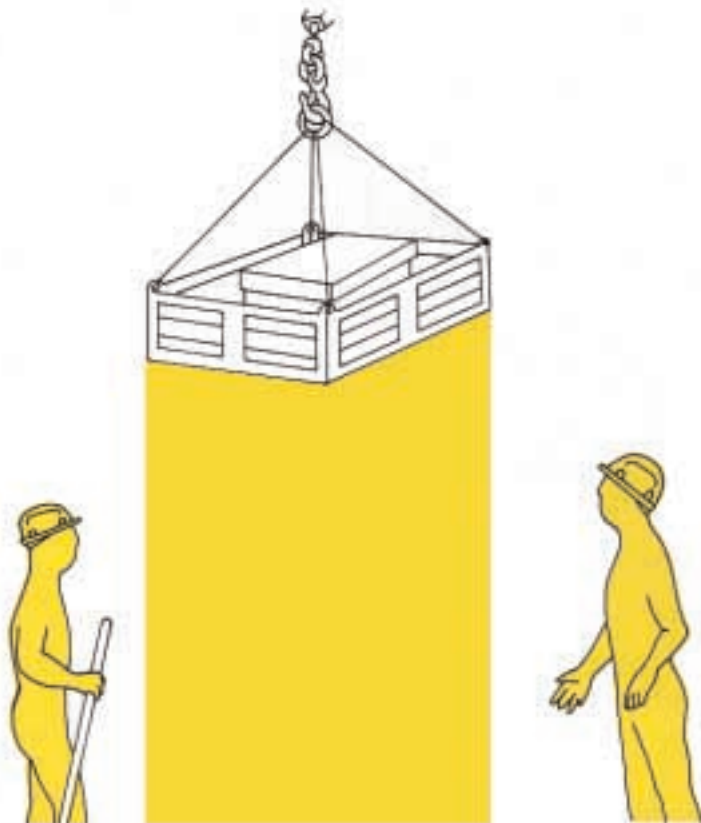

Pericolo di caduta materiale
Rrezik rënie materialesh
Risque de chute de matériaux
Danger of falling material

خطر سقوط موادّ

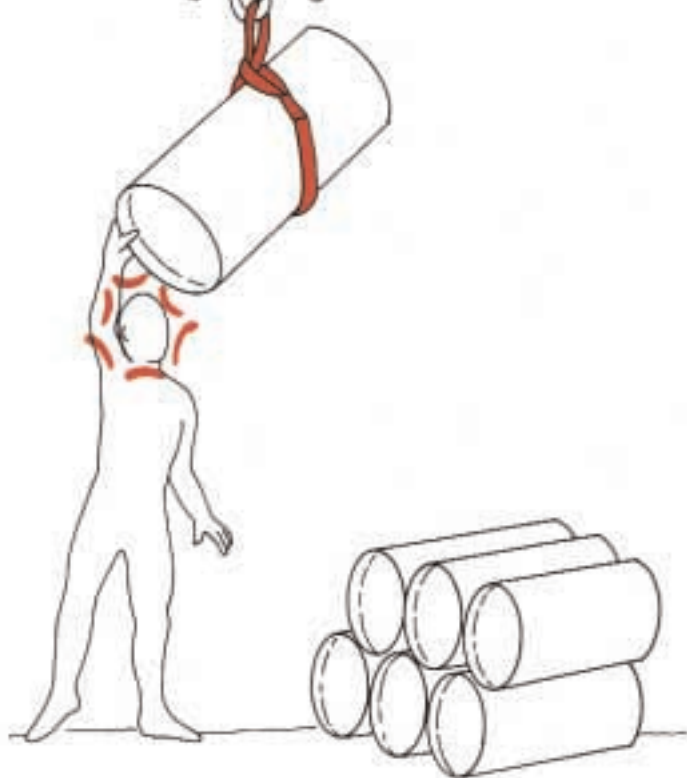

TAV. 33

Solleva il materiale con attrezzature adatte
Ngrihi materialet me pajisje të përshtatshme
Soulever les matériaux avec des équipements adaptés
Use appropriate lifting equipment

إرفع الموادّ بواسطة أجهزة ملائمة

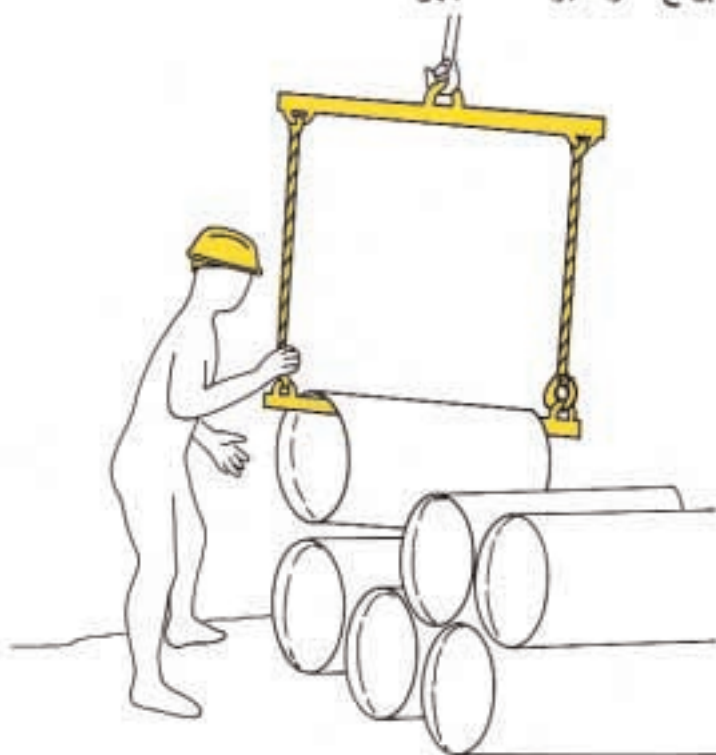

TAV. 34

Pericolo di caduta materiale
Rrezik rënie materialesh
Risque de chute de matériaux
Danger of falling material

خطر سقوط مواد

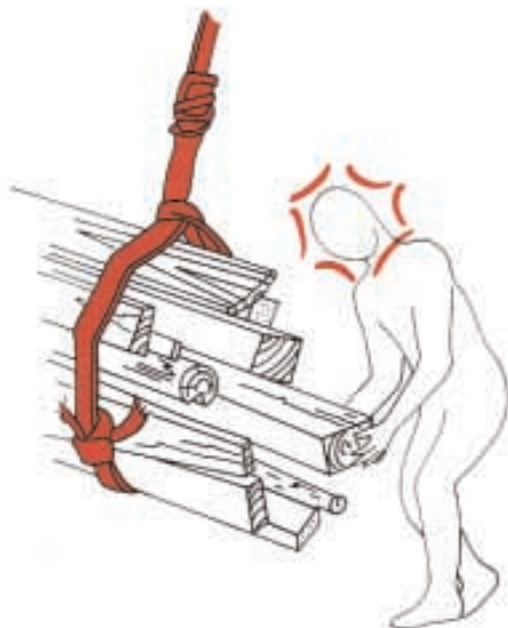

Solleva il materiale con attrezzature adatte
Ngrïhi materialet me pajisje te përshtatshme
Soulever les matériaux avec des équipements adaptés
Use appropriate lifting equipment

أرفع المواد بواسطة أجهزة ملائمة



Pericolo crollo gru

Rrezik rënie vinci

Risque d'écroulement de la grue

Danger of crane collapse

خطر انهيار الرافعة

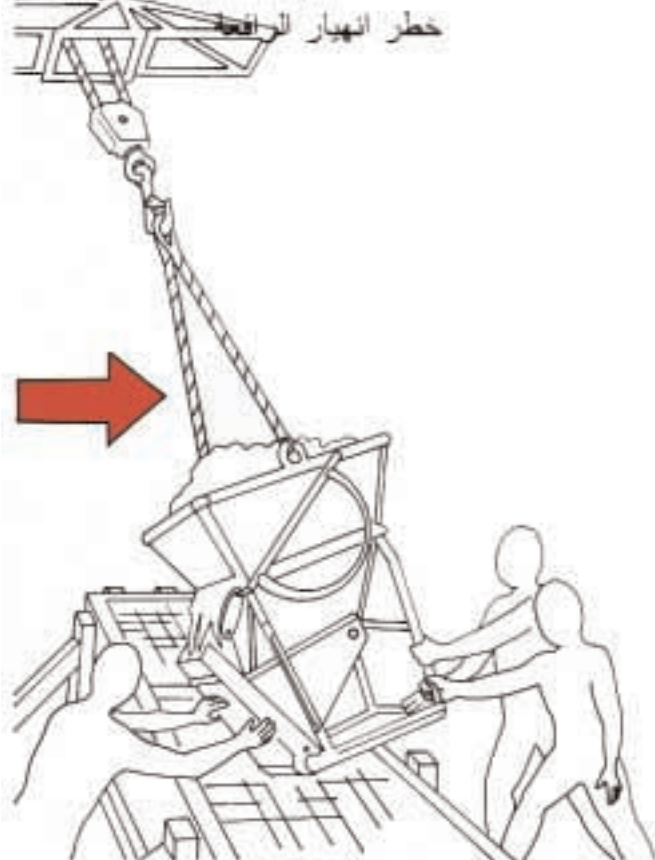

Non fare tiri obliqui

Mos kryej tërheqje të pjerret

Ne pas tirer en oblique

Do not pull diagonally

لا تقم بسحب أو شدّ مائل

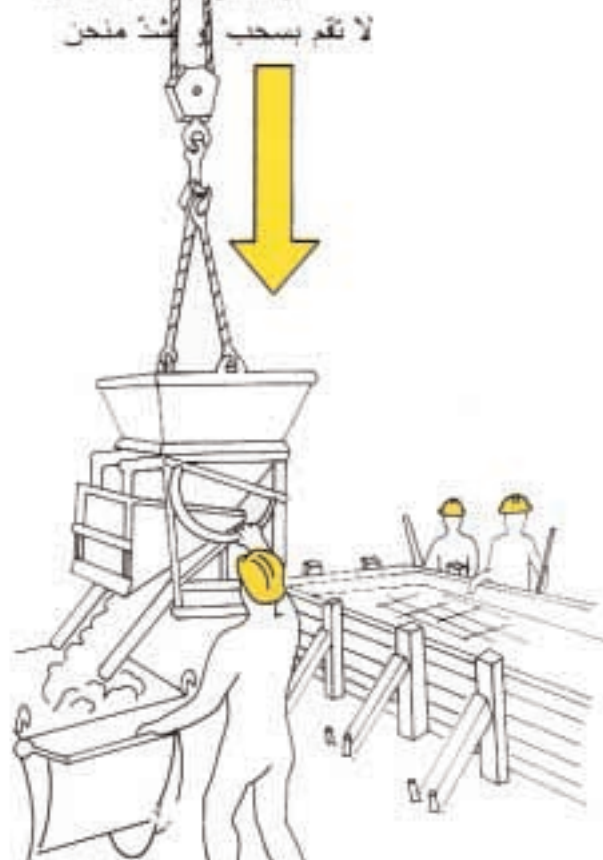

Pericolo di caduta, di schiacciamento e urti
Rrezik rënie, shtypjeje dhe goditjeje
Risques de chute, d'écrasement et de chocs
Danger of falling, crushing and impact

خطر سقوط وسحق واصطدام

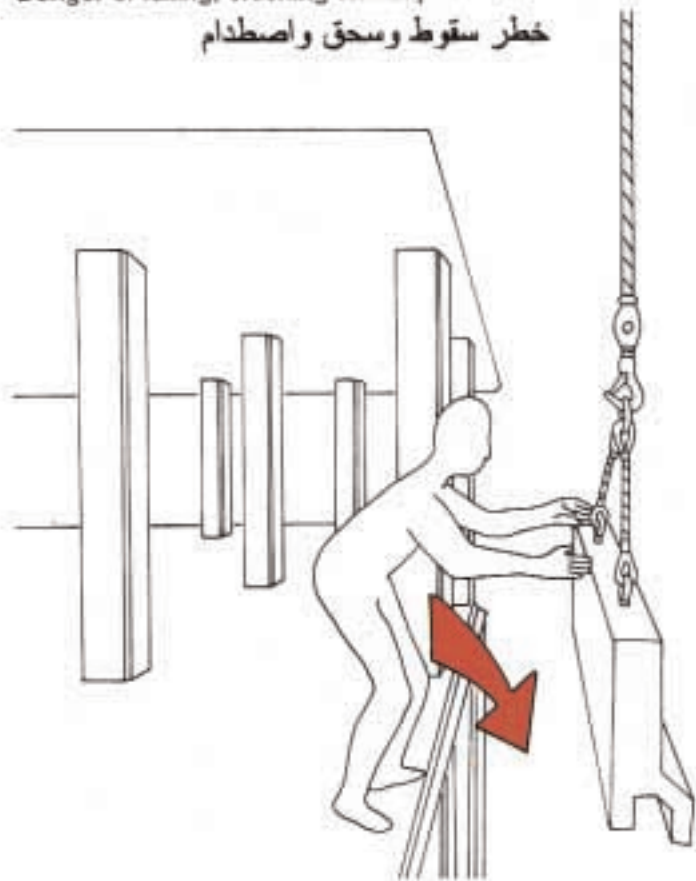

TAV. 36

Usa i dispositivi di protezione individuale
Përdor pajisjet e mbrojtjes individuale
Utiliser les dispositifs de protection individuelle
Use individual safety gear

إستعمل أدوات الحماية الفردية

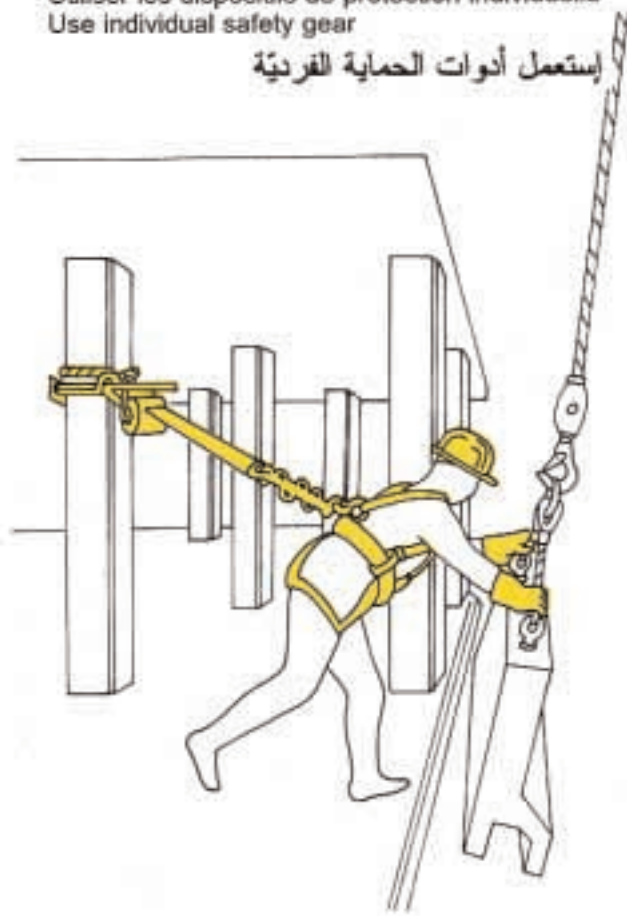

TAV. 37

Quando scavi osserva le misure previste
Kur gërmon respekto masat e parashikuara
Quand vous creusez respectez les mesures prévues
Observe proper safety measures when digging

عندما تحفر، تقيّد بالقياسات المقررة

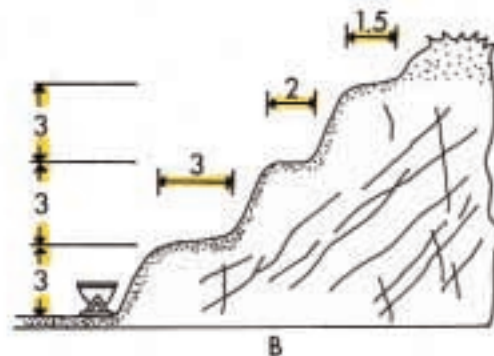
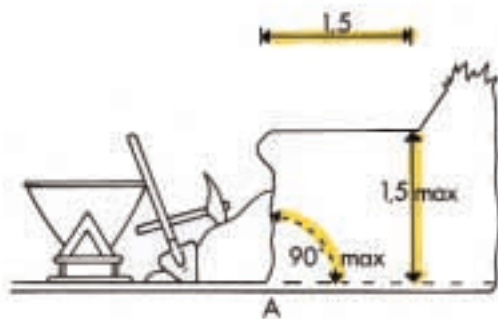

Pericolo di crollo del terreno
 Rrezik shembje terren
 Risque d'ecroulement du terrain
 Danger of ground collapse

خطر انهيار التربة

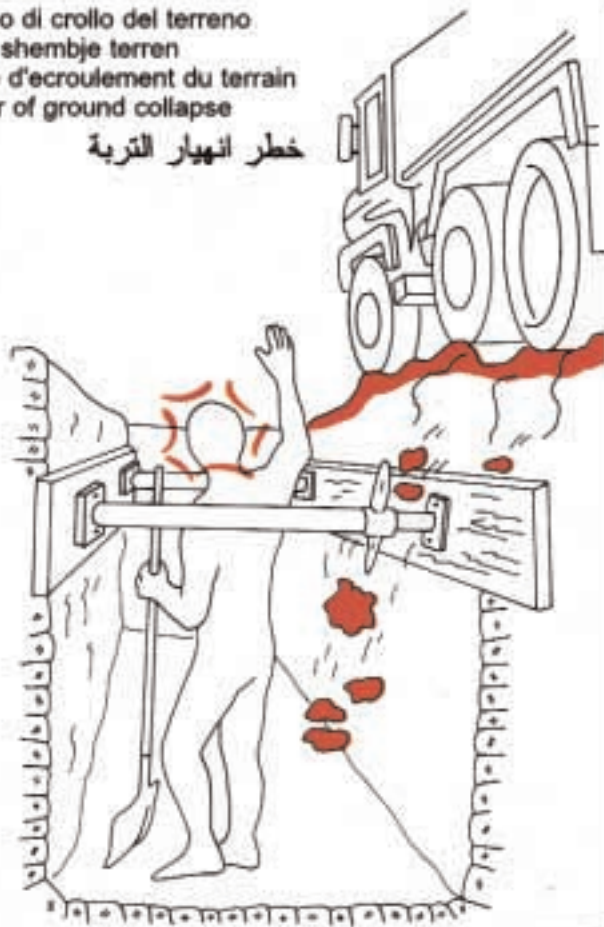

Sorreggi le pareti e allontana i mezzi di trasporto
 Mba paretet që të mos bien dhe largo mjetet e transportit
 Soutenir les parois et éloigner les engins de transport
 Support walls and keep vehicles away

دعم الجدران (أو الحدران) وأبعد وسائل النقل

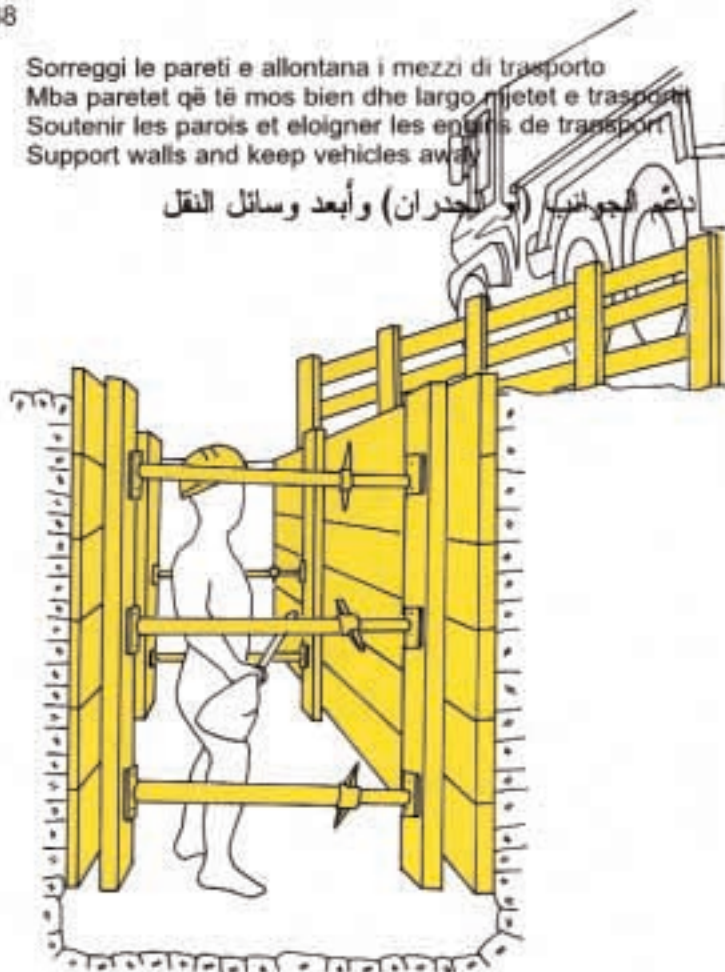

Pericolo di crollo del terreno
 Rrezik shembje terreni
 Risque d'écroulement du terrain
 Danger of ground collapse

خطر انهيار التربة

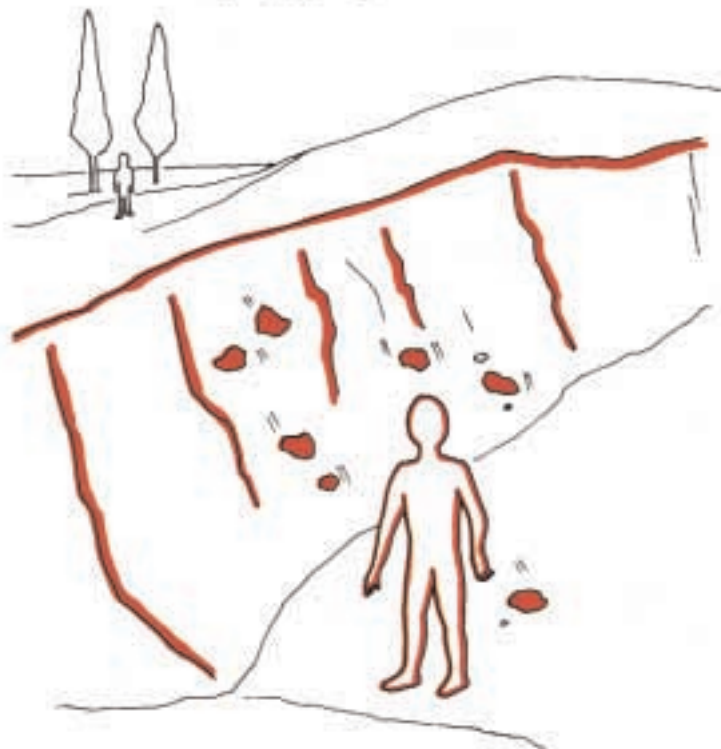

Sorreggi la parete
 Mba paretin që të mos bjerë
 Soutenir la paroi
 Support walls

دعم الجانب (أو الجدار)

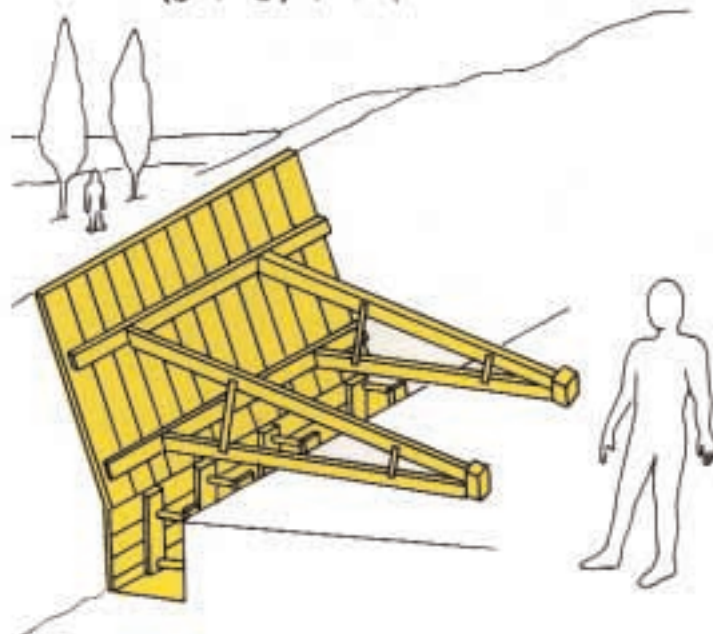

TAV. 40

Pericolo di crollo del terreno
Rrezik shembje terreni
Risque d'écroulement du terrain
Danger of ground collapse

خطر انهيار التربة



Inclina le pareti e allontana i mezzi di trasporto
Pjerrëso paretet dhe largo mjetet e transportit
Incliner les parois et éloigner les véhicules de transport
Tilt walls and keep vehicles away

أخذ الجوانب وأبعد وسائل النقل



TAV. 41

Sorreggi le pareti dello scavo
Siguro mbajtjen nga rënia të pareteve të vendit ku gërmon
Soutenir les parois du cavage
Support dig walls

دعم جوانب الحفرية

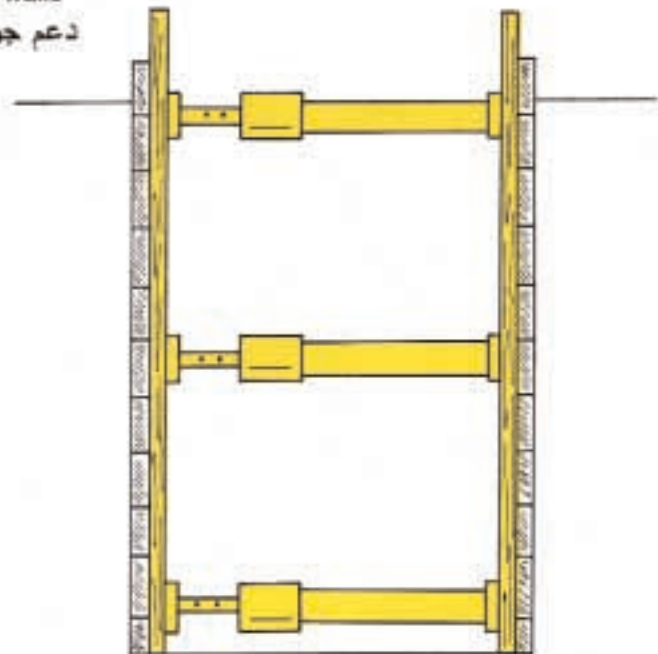
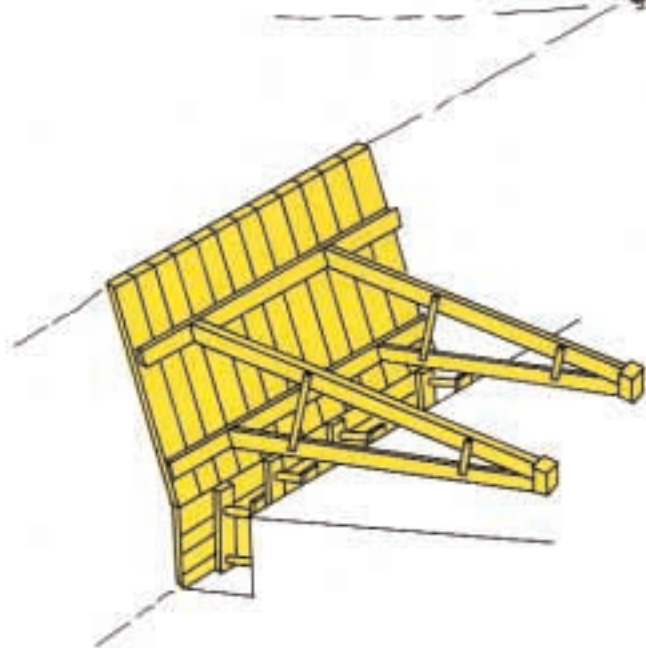

Pericolo di caduta
Rrezik rënie
Risque de chute
Danger of falling

خطر سقوط

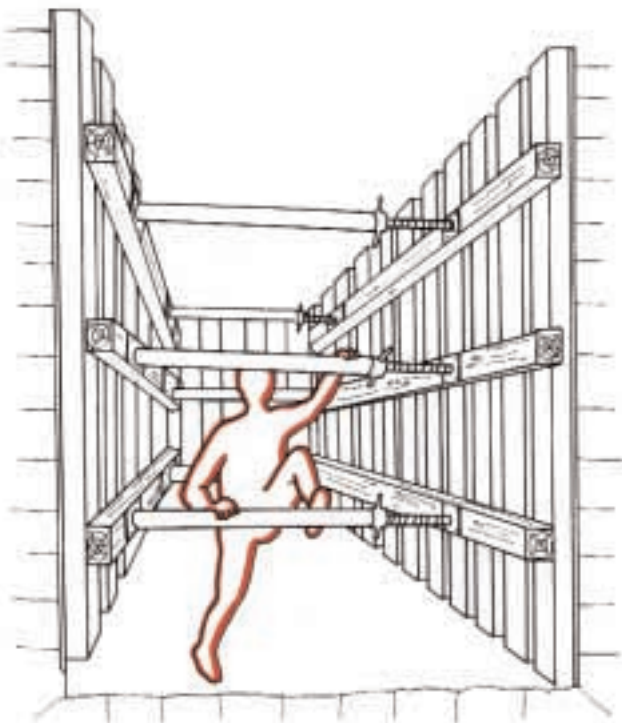

TAV. 42

Usa la scala
Përdor shkallën
Utiliser l'échelle
Use ladder

إستعمل السلم

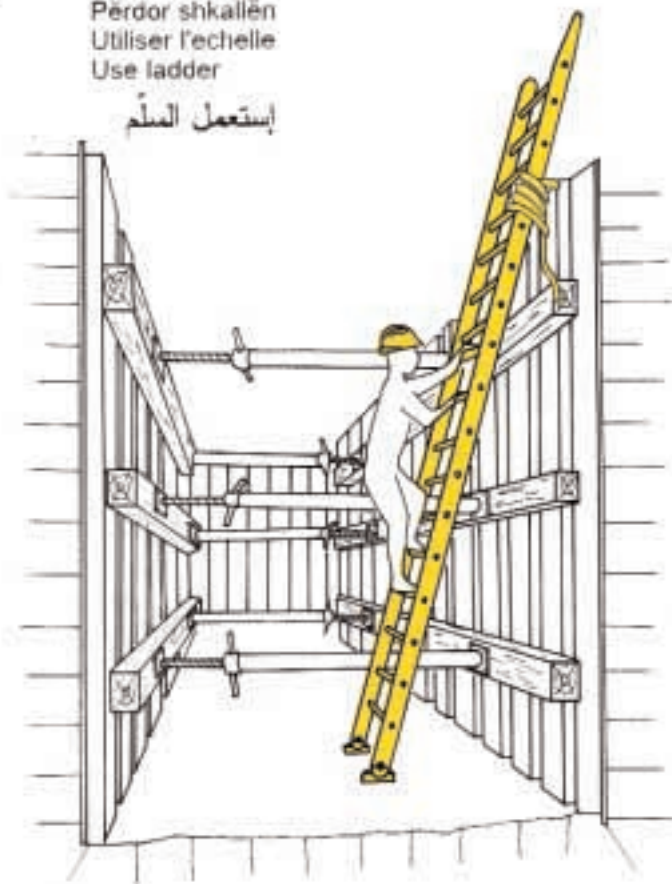

Pericolo di caduta materiale
 Rrezik rënie materiali
 Risque de chute de matériaux
 Danger of falling material

خطر سقوط مواد



Demolisci dall'alto verso il basso
 Shemb nga lartë, poshtë
 Demolir ,en commençant par le haut
 Demolish from top down

دمر من أعلى إلى أسفل



TAV. 44

Pericolo di caduta
Rrezik rënie
Risque de chute
Danger of falling

خطر سقوط

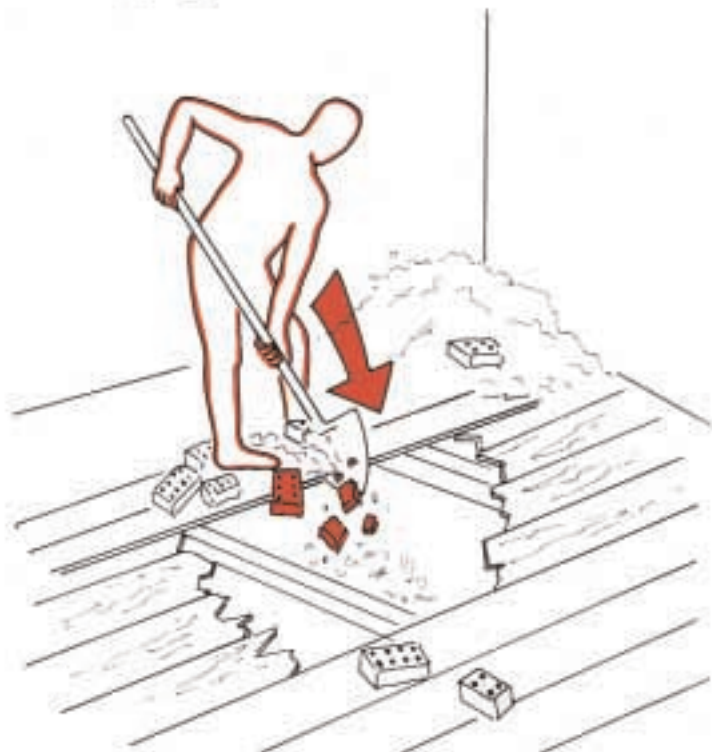

Metti il parapetto e convoglia le macerie
Vendos parapetin dhe grumbullo e largo gërmadhat
Mettre le parapet et canaliser les gravats
Install railing and convey scrap

ضع الحاجز واقنف الانقاض

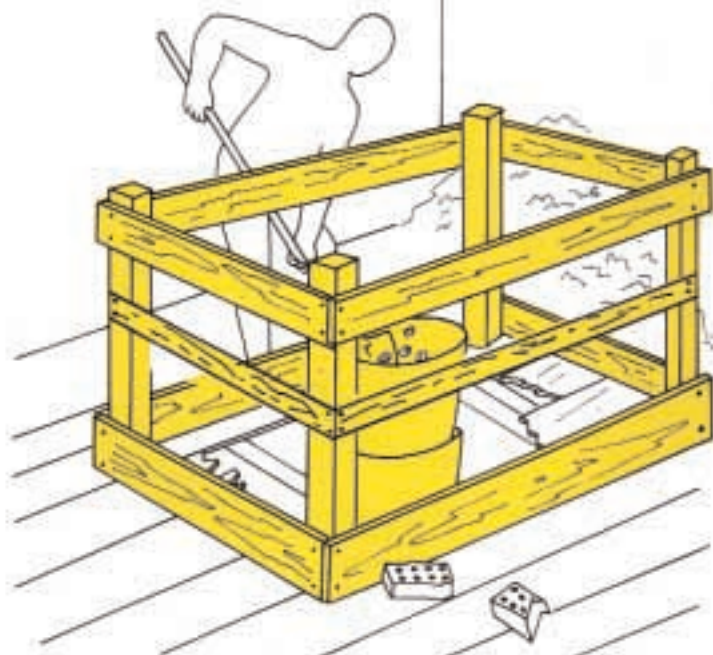

Pericolo di caduta materiale
Rrezik rënie materiali
Risque de chute de matériaux
Danger of falling material

خطر سقوط موادّ

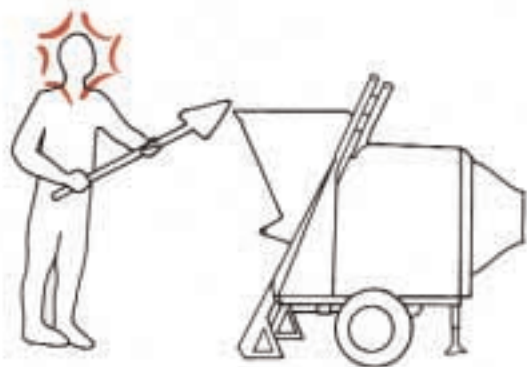
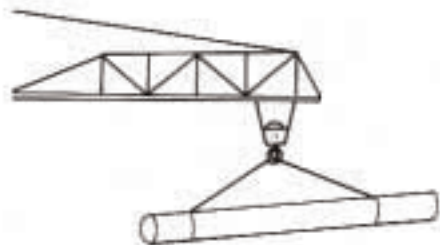

TAV. 45

Prevedi l'impalcato di protezione
Parashiko skelë mbrojtëse
Prevoir le plancher de protection
Build safety sheds

إستعمل سقالة الحماية

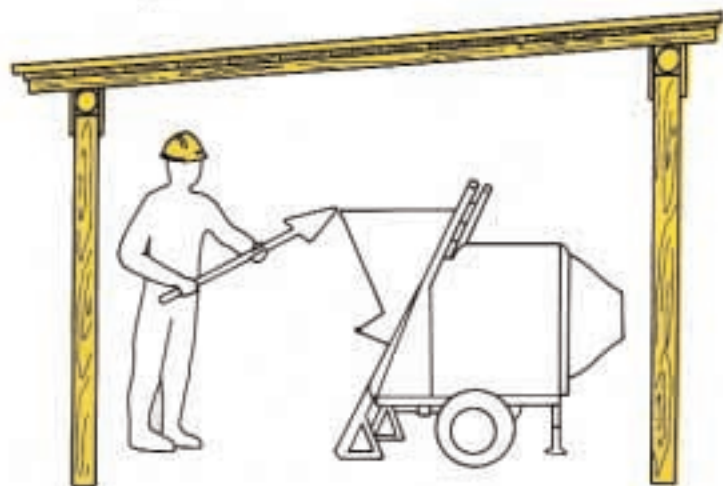
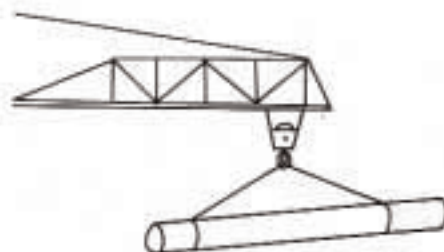

Pericolo di schiacciamento
Rrezik shtypje
Risque d'écrasement
Danger of crushing

خطر سحق

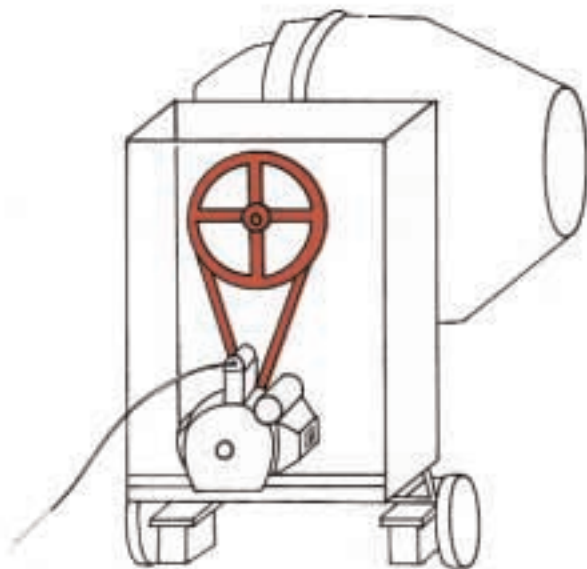

Metti la protezione
Vendos pjesë mbrojtëse
Mettre la protection
Install guard

ضع الحماية

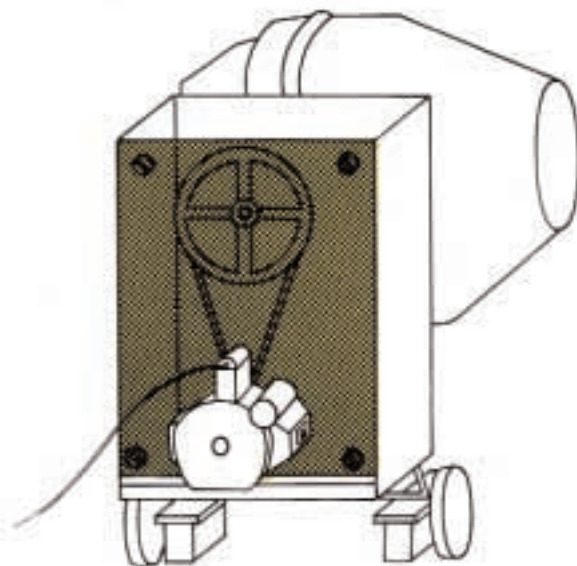

No!!
Joff
Non!!
No!!
!! √

TAV. 47

Si
Po
Oui
Yes
E

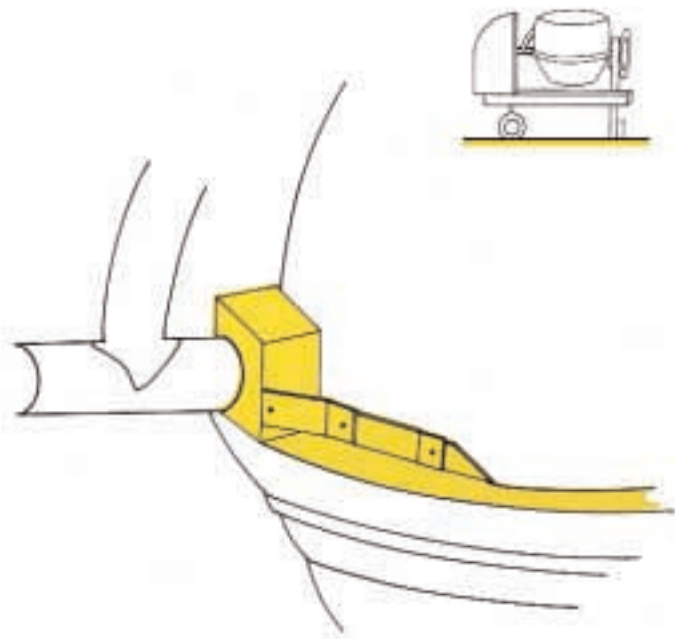
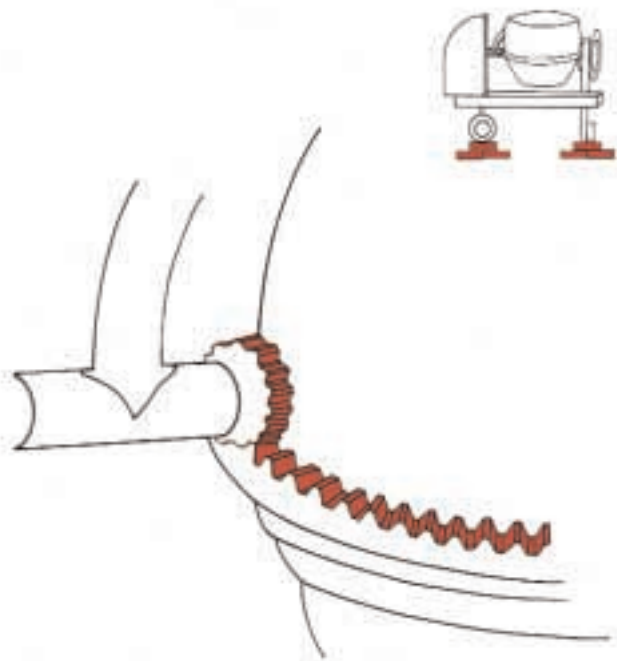

No!!
Jo!!
Non!!
Nol!
!! لا

Delimita la zona di lavoro
Kufizo zonën e punës
Delimiter la zone de travail
Designate working area

حدّد منطقة العمل

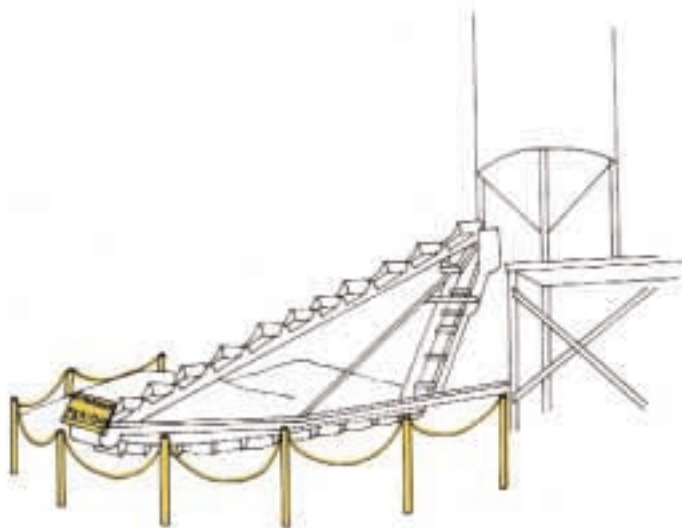

No!!
Jo!!
Non!!
No!!
!! ❌

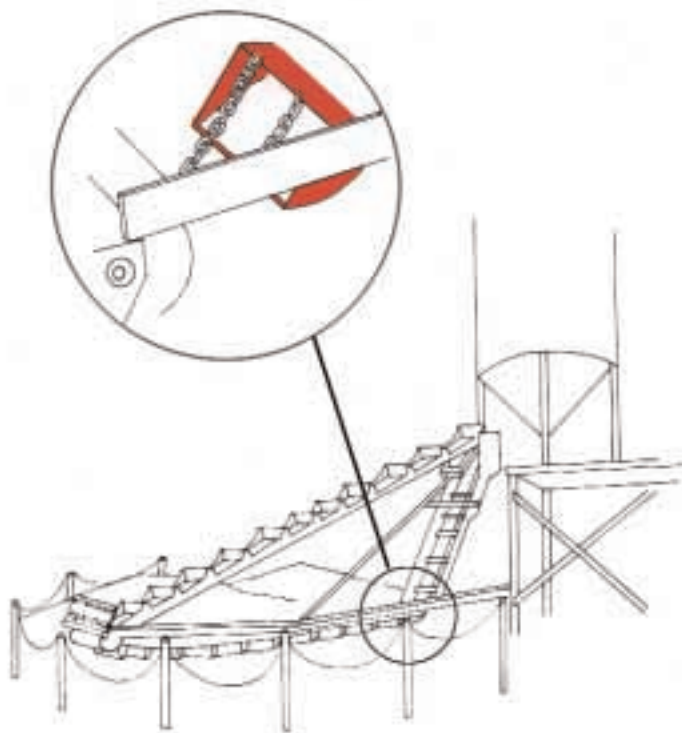

TAV. 49

Usa il raggio raschiante con fune di sicurezza, controllare che la fune interrompa il moto
Përdor sistemin ngarkues automatik i rërës (gërryers) me litarin e sigurimit, kontrollo që litarin ndërpret motorrin
Utiliser le racleur avec une cordelette de sécurité, contrôler que la cordelette interrompe le mouvement
Use the radius lift arm with the safety cord. Make sure cord breaks the movement.

استعمل الشعاع الصافل بحبل الامان وتأكد من ان الحبل يوقف الحركة

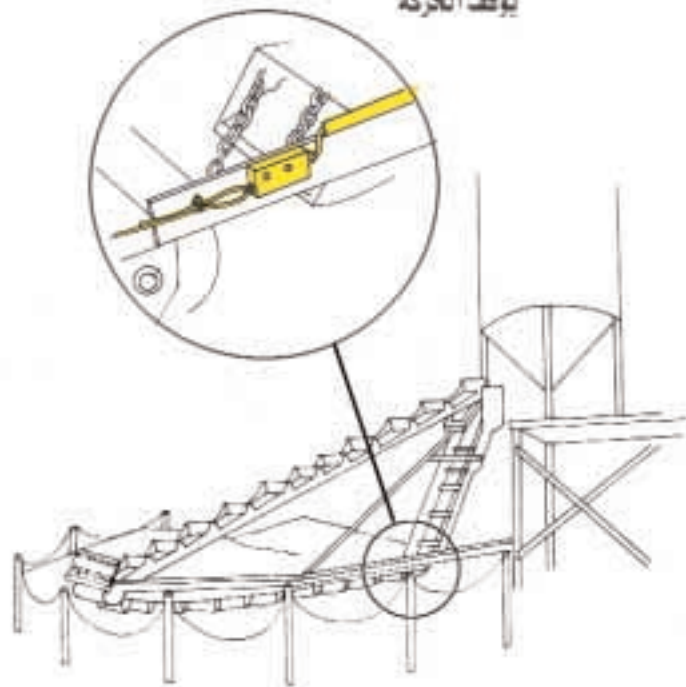

No!!
Jo!!
Non!!
No!!
!! Y

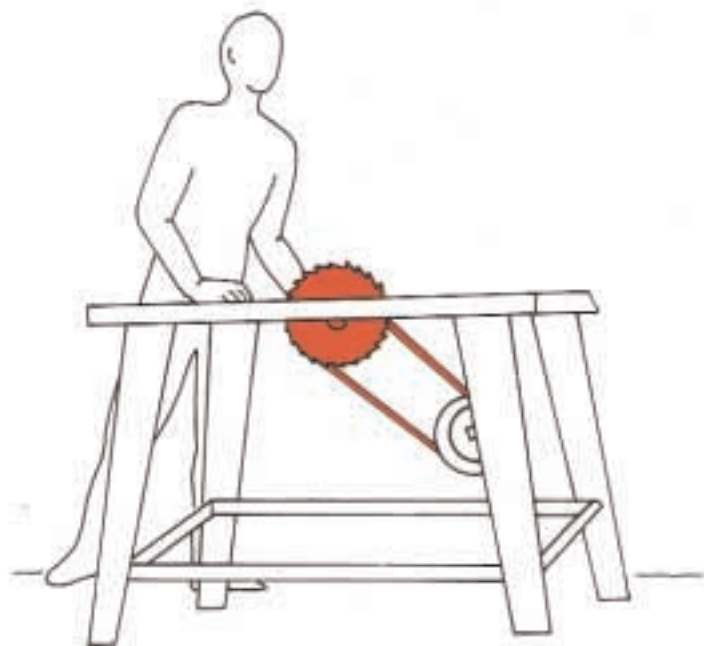

Si
Po
Oui
Yes
E

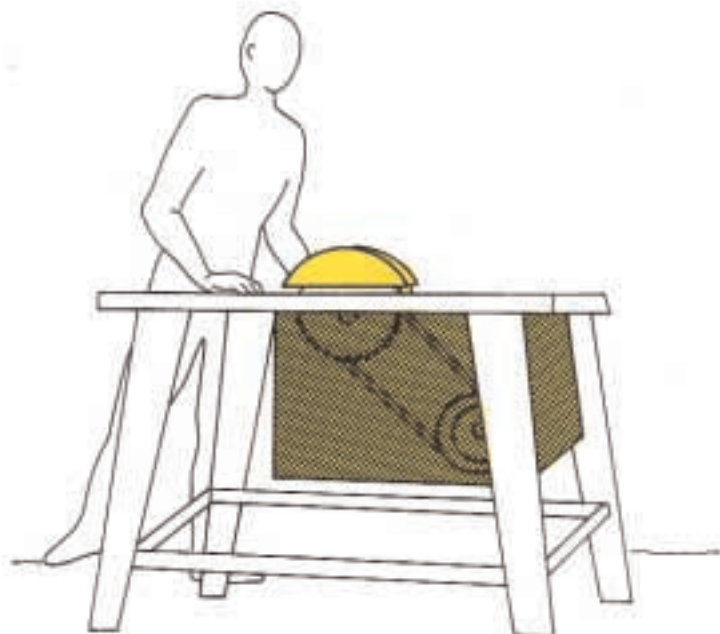

No!!
Jo!!
Non!!
No!!
!! لا

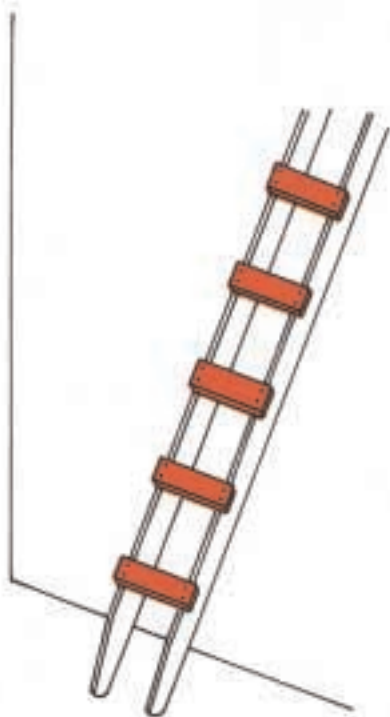

Usa scale sicure
Përdor shkallë të sigurta
Utiliser une échelle sûre
Use safety ladders

إستعمل سلالم آمنة

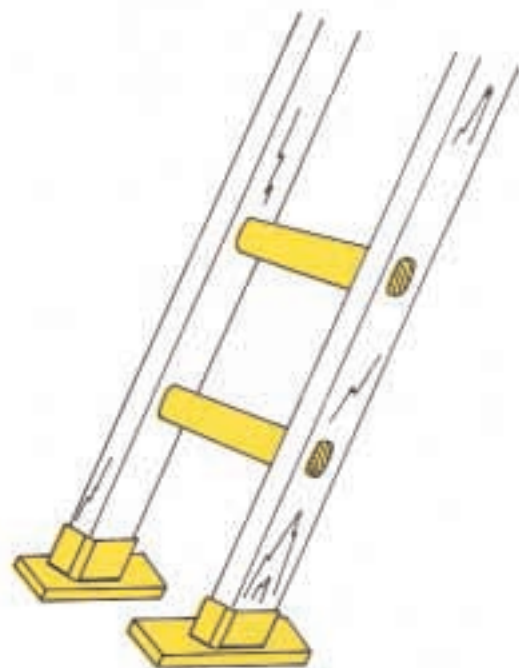

No!
Jo!
Non!
Noll
!! لا



Lega la scala
Lidh shkallën
Attacher l'echelle
Fasten ladder in place

إربط السلم



No!!
Joff
Non!!
No!!
!! √

TAV. 53

Si
Po
Oui
Yes
E

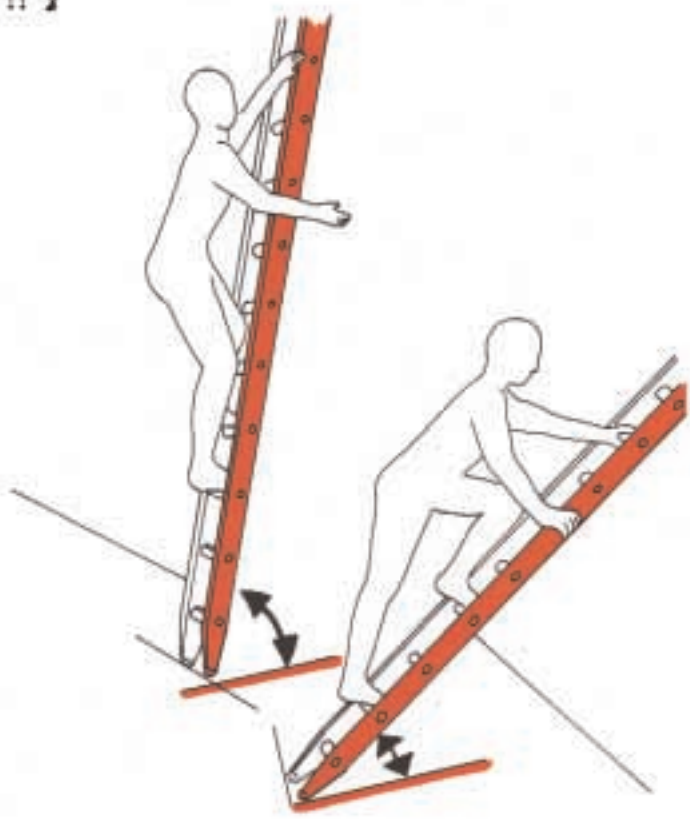

Pericolo di folgorazione
Rrezik goditje nga rryma elektrike
Risque d'electrocution
Danger of electrocution

خطر انصعاق بالتيار الكهربائي



Usa lampade adatte al luogo
Përdor llamba të përshtatshme me vendin
Utiliser des ampoules adaptées au lieu
Use suitable lamps

إستعمل مصابيح ملائمة للموقع



TAV. 55

Pericolo di folgorazione
Rrezik goditje nga rryma elektrike
Risque d'electrocution
Danger of electrocution
خطر انصعاق بالتيار الكهربائي

Rispetta la distanza di sicurezza
Respekto distancën e sigurisë
Respecter la distance de securite
Observe safety distances
تقيّد بمسافة الأمان

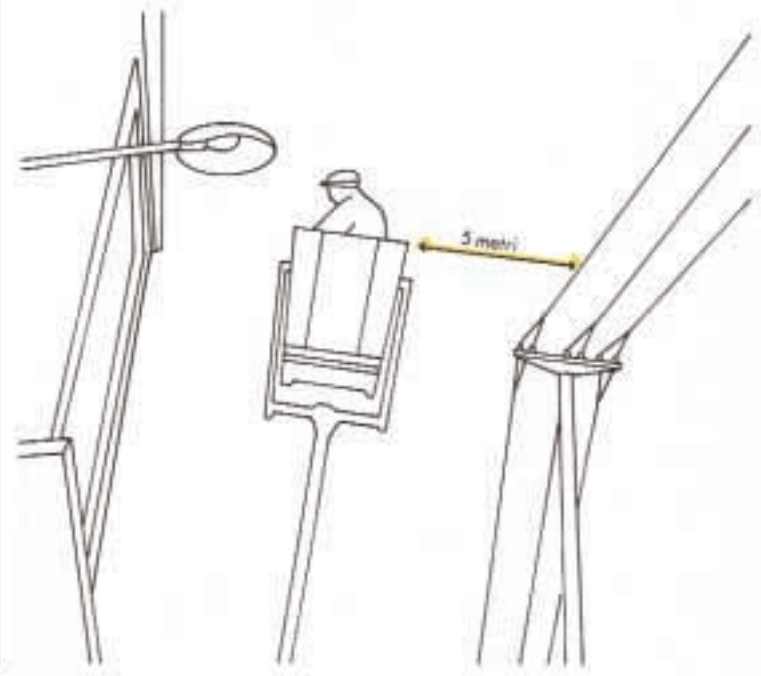
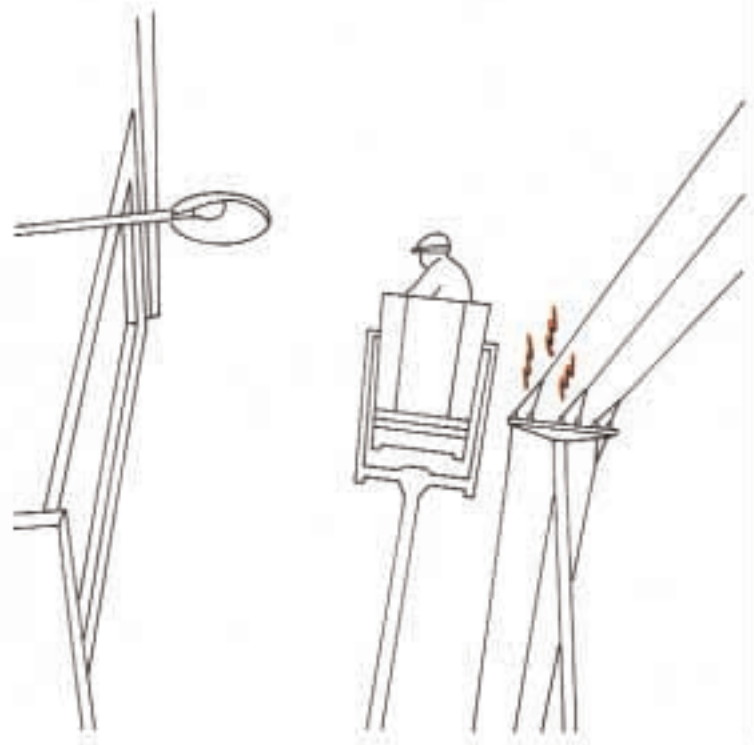

TAV. 56

Pericolo di folgorazione
Rrezik goditje nga rryma elektrike
Risque d'electrocution
Danger of electrocution

خطر انصعاق بالتيار الكهربائي



Usa utensili elettrici certificati in doppio isolamento
Përdor makinat elektrike të siguruar, dyfish të izoluar
Utiliser des outils électriques certifiés à double isolation
Use certified double insulation electric tools only.

استعمل الآلات الكهربائية الموثوقة ذات العزل الثنائي



Pericolo di folgorazione
 Rrezik goditje nga rryma elektrike
 Risque d'electrocution
 Danger of electrocution

خطر انصعاق بالتيار الكهربائي



Controlla il collegamento di terra
 Kontrolllo tokëzimin
 Contrôler le groupement de terre
 Check grounding

راقب الاتّصال الأرضي

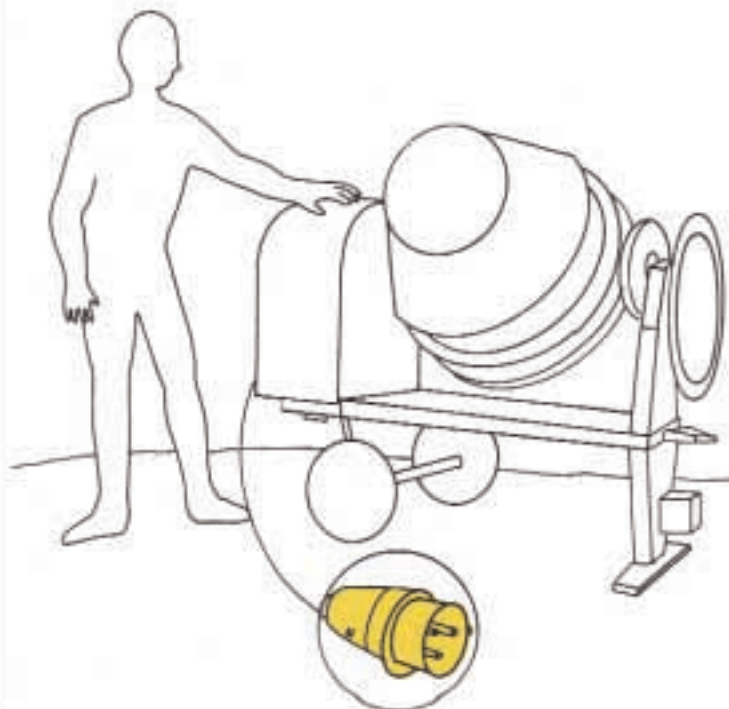

TAV. 58

No!
Joll
Non!
No!
لا !!

Livellamento del getto di calcestruzzo
Rrafshim i hedhjes të betonit
Nivellement de la coulée de béton
Concrete jet levelling.
تسوية البثاق الحرسانة

Si
Po
Oui
Yes
نعم



TAV. 59

No!!
Joff
Non!!
No!!
لا !!

Sollevamento e trasporto sacchi
Ngre dhe transportim thesësh
Levage et transport de sacs
Sack lifting and transfer

رفع ونقل الأكياس

Si
Po
Oul
Yes
نعم

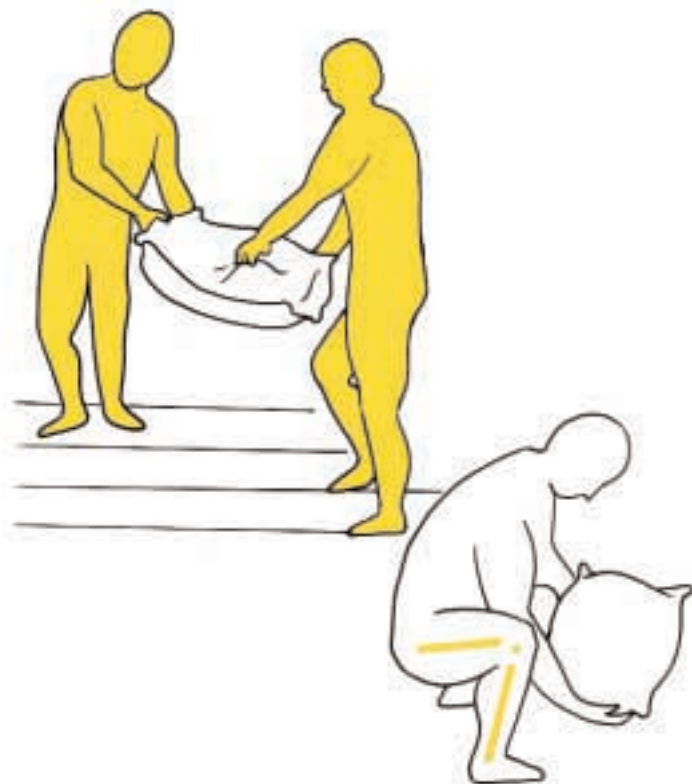
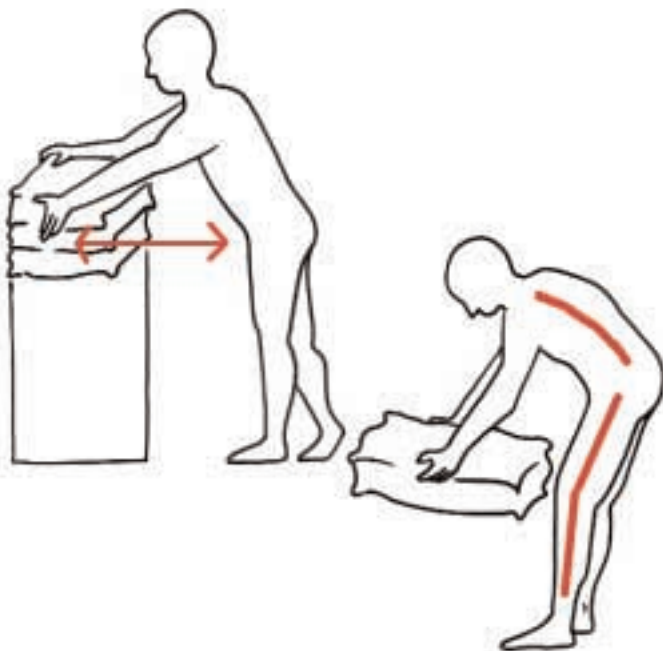

TAV. 60

No!
Jo!
Non!
No!
لا !!

Trasporto sacchi
Trsportim thesësh
Transport de sacs
Sack transport.

Si
Po
Oui
Yes
نعم

نقل الأكياس



TAV. 61

Posa del materiale di copertura tetto
Vendos materialin për mbulimin e çatis
Pose de matériel pour la toiture
Roofing material laying

وضع مواد تغطية السقف

No!
Jo!
Non!
Nol!
لا !!



Si
Po
Oui
Yes
نعم



No!!
Jo!!
Non!!
No!!
لا !!

TAV. 62

Posa dei laterizi
Vendos tullat
Pose de briques
Brick laying
وضع مواد البناء أجر قريميد-

Si
Po
Oui
Yes
نعم



No!!
Jo!!
Non!!
No!!
لا !!

TAV. 63
trasporto laterizi
Zhvendos tullat
Transport de briques
Brick transport.
نقل مواد بناء

Si
Po
Oui
Yes
نعم

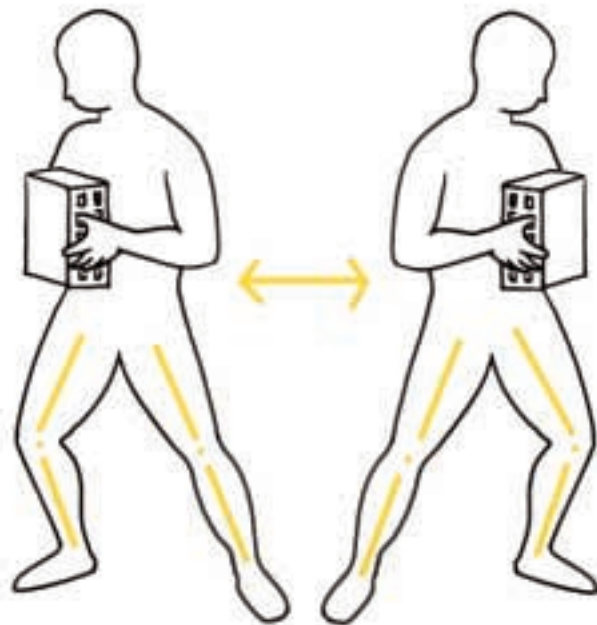

TAV. 64

No!!
Jo!!
Non!!
No!!
لا !!

Applicazione malte e intonaci
Zbatim i ilaçit dhe suvatim
Application de mortiers et de crépis
Mortar and plaster application
استعمال الملاط والعتلاء

Si
Po
Oui
Yes
نعم



No!
Joll
Non!
Noll
!! لا



TAV. 65

Intonacatura e lisciatura
Suvatim dhe lërimim i tij
Crépissage et polissage
Plastering and smoothing

طلاء وتلميس

Si
Po
Oui
Yes
نعم



No!!
Jo!!
Non!!
No!!
لا !!



TAV. 66

Usa acqua corrente
Përdor ujë të rrjedhshëm
Utiliser de l'eau courante
Use running water

استعمل مياه جارئة

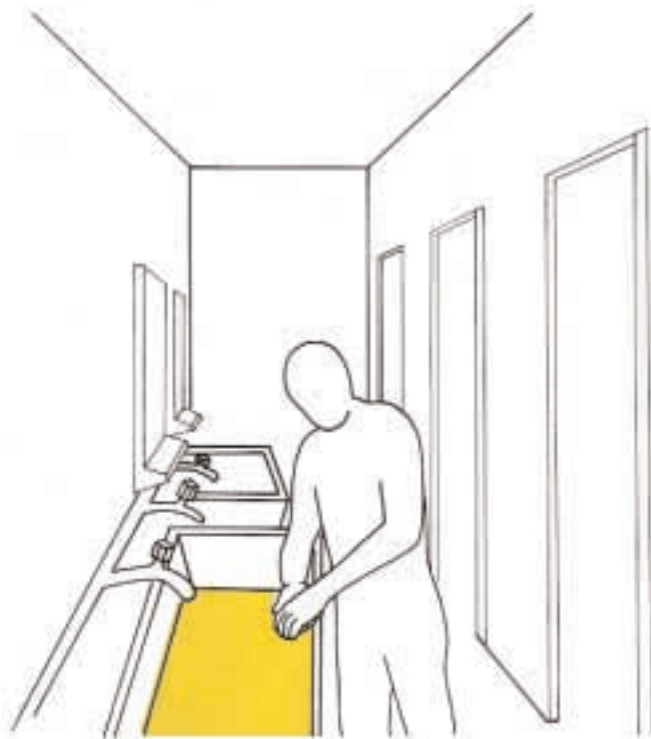

No!!
Jo!!
Non!!
Noll
!! لا



Mangia in luoghi puliti
Ha nē vende tē pastra
Manger dans des lieux propresnoll
Eat in a clean place

تناول الأكل في أماكن نظيفة

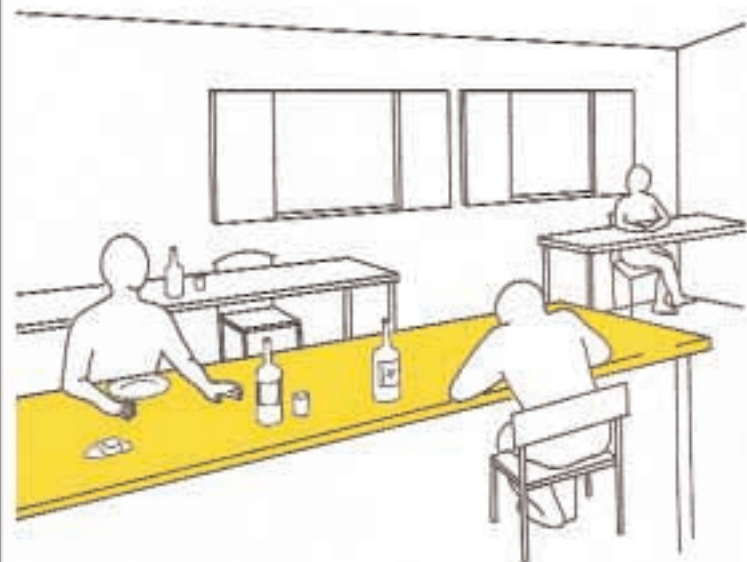

Per ulteriori chiarimenti è possibile rivolgersi:
Azienda Provinciale per i Servizi Sanitari
Direzione Igiene e Sanità Pubblica
Unità Operativa
Prevenzione e Sicurezza Ambienti Lavoro
Nucleo impianti e cantieri
Tel. 0461 364500-02 Fax 0464 364540